

### MECHANICAL DATA

Bulb . . . . .	T-3
Base . . . . .	E8-10, Subminiature Button Flexible Leads
Outline . . . . .	JETEC 3-1
Basing . . . . .	8DL
Cathode . . . . .	Coated Unipotential
Mounting Position . . . . .	Any

### RATINGS<sup>1</sup> (Absolute Maximum)

Impact Acceleration . . . . .	450 G
Uniform Acceleration . . . . .	1000 G
Fatigue (Vibrational Acceleration for Extended Periods) . . . . .	2.5 G
Bulb Temperature . . . . .	220° C
Altitude <sup>2</sup> . . . . .	80000 Ft.

### ELECTRICAL DATA

#### HEATER CHARACTERISTICS

	Min.	Bogey	Max.
Heater Voltage <sup>3</sup> . . . . .	25.2	26.5	27.8 V
Heater Current . . . . .		45	mA

#### DIRECT INTERLODE CAPACITANCES

	Shielded <sup>4</sup>	Unshielded	Max.
Grid No. 1 to Plate . . . . .	0.015	0.03 $\mu\text{mf}$	
Input . . . . .	4.2	4.0 $\mu\text{mf}$	
Output . . . . .	3.4	1.9 $\mu\text{mf}$	

### RATINGS<sup>1, 5</sup> (Absolute Maximum)

Plate Voltage . . . . .	165 Vdc
Peak Plate Forward Voltage <sup>6</sup> . . . . .	330 v
Grid No. 2 Voltage . . . . .	155 Vdc
Plate Dissipation . . . . .	1.1 W
Grid No. 2 Dissipation . . . . .	0.55 W
Cathode Current . . . . .	16.5 mAdc
Grid No. 1 Voltage . . . . .	
Positive Value . . . . .	0 Vdc
Negative Value . . . . .	55 Vdc
Heater-Cathode Voltage . . . . .	
Heater Positive with Respect to Cathode . . . . .	200 v
Heater Negative with Respect to Cathode . . . . .	200 v
Grid No. 1 Circuit Resistance . . . . .	1.1 Meg

### CHARACTERISTICS

Plate Voltage . . . . .	100 Vdc
Grid No. 2 Voltage . . . . .	100 Vdc
Cathode Resistor . . . . .	150 Ohms
Plate Current . . . . .	7.5 mAdc
Grid No. 2 Current . . . . .	2.4 mAdc
Transconductance . . . . .	5000 $\mu\text{mhos}$
Plate Resistance . . . . .	260000 Ohms
Grid No. 1 Voltage for $I_b = 50 \mu\text{Adc}$ Max. . . . .	-9.0 Vdc

### NOTES:

1. Limitations beyond which normal tube performance and tube life may be impaired.
2. If altitude rating is exceeded, reduction of instantaneous voltage (Ef excluded) may be required.
3. Tube life and reliability of performance are directly related to the degree of regulation of the heater voltage to its center rated value of 26.5 volts.
4. External shield of 0.405 inch diameter connected to cathode.
5. Values shown are as registered with RETMA.
6. Per MIL-E-1C Par. 6.5 and General Section of this Sylvania Subminiature Tube Manual titled Specifications and Ratings.

### QUICK REFERENCE DATA

The Premium Subminiature Type 5906 is a sharp cutoff pentode characterized by long life and stable performance under conditions of severe shock, vibration, high temperature and high altitude. Except for heater characteristics, the Type 5906 is identical to the Type 5840. The 5906 employs a 26.5 volt, 45 ma heater.

The 5906 is suited to a variety of low frequency applications as well as rf amplifier service at frequencies up to 400 mc.

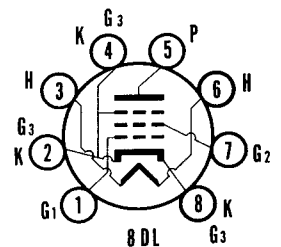
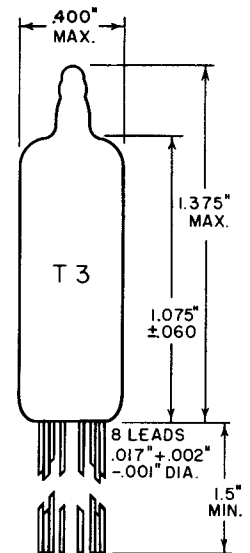

SYLVANIA ELECTRIC PRODUCTS INC.

RADIO TUBE DIVISION  
EMPORIUM, PA.

Prepared and Released By The  
TECHNICAL PUBLICATIONS SECTION  
EMPORIUM, PENNSYLVANIA

AUGUST, 1957

PAGE 1 OF 10

ACCEPTANCE CRITERIA

Test Conditions

Heater Voltage . . . . .	26.5 V	Grid No. 2 Voltage . . . . .	100 Vdc
Plate Voltage . . . . .	100 Vdc	Heater-Cathode Voltage MIL-E-1 Par. 3.2.2.1 . . . . .	0 V
Grid No. 1 Voltage . . . . .	0 V	Cathode Resistor . . . . .	150 Ohms

For the purposes of inspection, use applicable reliable paragraphs of MIL-E-1 and Inspection Instructions for Electron Tubes.

MIL-E-1 Ref.	Tests	Limits			Units
		Min.	Bogey	Max.	
<b>Production Tests</b>					
4.10.8	Heater Current:.....	40	45	50	mA
4.10.6.1	Grid No. 1 Current:.....	0	—	-0.3	μA <sub>dc</sub>
4.10.4.1	Plate Current: (1).....	5.5	7.5	9.5	mA <sub>dc</sub>
4.10.4.1	Plate Current (2)..... E <sub>c1</sub> = -9 Vdc	0	—	50	μA <sub>dc</sub>
4.10.4.3	Grid No. 2 Current:.....	0.5	2.4	3.5	mA <sub>dc</sub>
4.10.9	Transconductance (1):.....	4100	5000	5900	μmhos
<b>Special Design Tests</b>					
4.9.5.3	Subminiature Lead Fatigue:.....	4	—	—	Arcs
4.9.19.2	Vibration: F = 40 cps; G = 15; R <sub>p</sub> = 10K Ohms; C <sub>k</sub> = 1000 μf.....	—	—	60	mVac
4.10.15	Heater-Cathode Leakage: E <sub>hk</sub> = +100 Vdc.....	0	—	7	μA <sub>dc</sub>
	E <sub>hk</sub> = -100 Vdc.....	0	—	7	μA <sub>dc</sub>
4.8	Insulation of Electrodes: E <sub>g1</sub> -all = -100 Vdc; E <sub>f</sub> = 26.5 V.....	100	—	—	Megs
4.10.3.2	AF Noise: E <sub>sig</sub> = 70 mVac; R <sub>g1</sub> = 0.1 Meg; R <sub>g2</sub> = 1000 Ohms; R <sub>p</sub> = 0.2 Meg; E <sub>cc2</sub> = 19 Vdc; E <sub>bb</sub> = 100 Vdc.....	—	—	17	VU
<b>Design Tests</b>					
4.10.9	Transconductance (2): E <sub>f</sub> = 24.0 V;.....	3750	—	—	μmhos
4.10.10	Plate Resistance:.....	0.150	—	—	Meg
4.10.14	Capacitance: 0.405" Dia. Shield Tied to Cathode				
	C <sub>g1p</sub> .....	—	—	0.015	μμf
	C <sub>in</sub> .....	3.5	4.2	4.9	μμf
	C <sub>out</sub> .....	2.9	3.4	3.9	μμf
<b>Degradation Tests</b>					
4.9.20.5	Shock: Note 1 Hammer Angle = 30°.....	—	—	—	
4.9.20.6	Fatigue: Note 1 F = 60 cps; G = 2.5; E <sub>f</sub> = 26.5 V.....	—	—	—	
----	Post Shock Test End Points: Vibration.....	—	—	200	mVac
----	Post Fatigue Test End Points: Vibration.....	—	—	100	mVac
----	Post Shock and Fatigue Test End Points: Heater-Cathode Leakage.....	—	—	20	μA <sub>dc</sub>
	Transconductance (1).....	3750	—	—	μmhos

ACCEPTANCE CRITERIA (Continued)

MIL-E-1 Ref.	Tests	Limits			Units
		Min.	Bogey	Max.	
<b>Acceptance Life Tests</b>					
4.11.7	Heater Cycling Life Test E <sub>f</sub> = 29.0 V; 1 min. On, 4 min. Off; E <sub>b</sub> = E <sub>c2</sub> = E <sub>c1</sub> = 0 V; E <sub>hk</sub> = 140 Vac.....	2500	—	—	Cycles
4.11.5	Intermittent Life Test: Note 2 R <sub>g1</sub> = 1.0 Meg; E <sub>hk</sub> = +200 Vdc; T <sub>A</sub> = 175°C.....	500	—	—	Hours
4.11.4	Intermittent Life Test End Points				
	Transconductance (1).....	3250	—	—	μmhos
	Heater-Cathode Leakage.....	0	—	20	μAdc
	Grid Current.....	—	—	-0.9	μAdc

ACCEPTANCE CRITERIA NOTES

- 1: Acceptance sampling procedure shall be in accordance with the shock test sampling procedure of the Inspection Instructions for Electron Tubes.
- 2: At the conclusion of the five hundred hour life test, the average life

of the life test sample shall be not less than four hundred fifty hours. Life test sample size shall be ten tubes. Provision for release of tubes prior to completion of life test on a reduced basis as specified in 4.3.1.3 Inspection Instructions for Electron Tubes shall not apply.

APPLICATION DATA

The 5906 is a subminiature sharp cutoff pentode characterized by long life and stable performance under conditions of severe shock, vibration, high altitude and high temperature. Except for heater characteristics, the 5906 is identical to the Type 5840. The 5906 employs a 26.5 volt, 45 ma heater. The 5906 is suited to a variety of low frequency applications as well as rf amplifier service at frequencies up to 400 mc.

As the frequency of operation is increased, consideration should be given to the resultant decrease in input and output resistance, Figure 1. Assuming matched input and output impedances, approximate tube gain can be obtained from the formula:

$$\text{Voltage Gain} = G_m \sqrt{\frac{R_{\text{input}} \times R_{\text{output}}}{2}}$$

where the values of R<sub>input</sub> and R<sub>output</sub> are obtain from the curves of Figure 1. The use of this formula assumes matched impedances into and out of the amplifier stage under consideration. If the source impedance is lower than the input resistance or if the load resistance is higher than the output resistance, much greater voltage gain per stage can be obtained than that indicated by the above formula. The voltage gain of a matching circuit is equal to the square root of the impedance ratio.

In some applications it may be advantageous to employ an unbypassed resistance in the cathode circuit to compensate for the change in input capacitance with bias. This unbypassed resistance reduces the effective G<sub>m</sub> of the tube by the factor

$$\frac{1}{1 + G_m R_k \left( \frac{I_b + I_{c2}}{I_b} \right)}$$

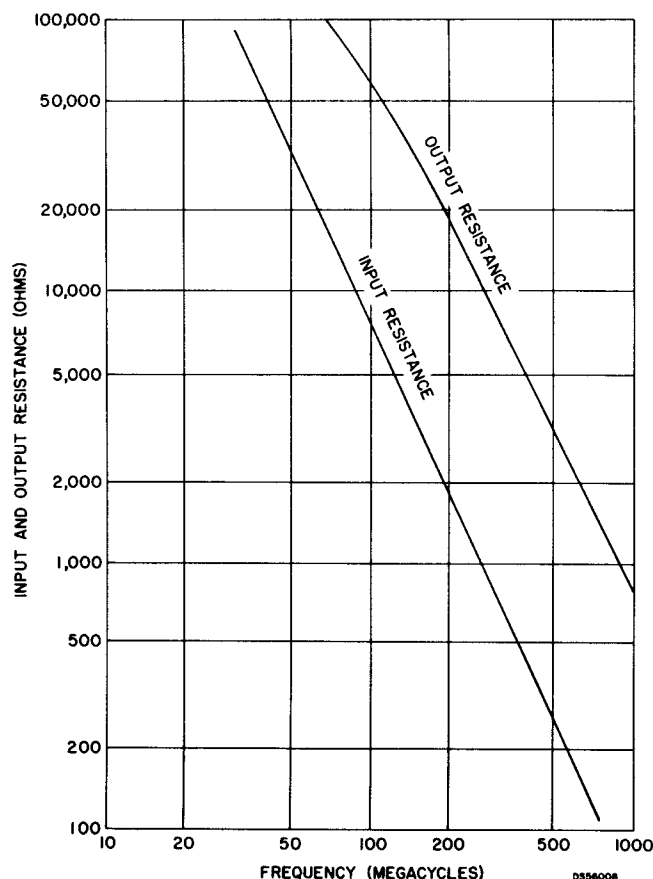

Figure 1—Input and output resistance vs frequency

APPLICATION DATA (Continued)

However, this unbypassed resistance also has the effect of raising the input resistance of the tube under certain operating conditions so that both a net increase in gain and a net decrease in input capacitance change may result. Some increase in effective grid-plate coupling may accompany these advantages.

The self neutralization frequency of the 5906 is approximately 200 mc. At this point the inductance of tube leads resonate with the grid plate capacitance to effect neutralization. At higher frequencies the feedback is inductive and takes place through the tube leads. Three cathode leads are provided to permit isolation of the input and output circuits.

Resistance coupled amplifier data is presented in the accompanying table.

Life expectancy is described by the life tests, specified on the attached pages and/or individual MIL-E-1 specifications. The actual life expectancy of the tube in an operating circuit is affected by both the operating and environmental conditions involved. Likewise, the life tests specified indicate performance under certain operating criteria to a set of specified end points. Performance at conditions other than those specified can usually be estimated only roughly as giving better or poorer life expectancy.

When operated under conditions common to on-off control applications the tube exhibits freedom from the development of interface resistance. The heater-cathode construction is designed to withstand intermittent operation.

RESISTANCE COUPLED AMPLIFIER DATA  
SELF-BIAS OPERATION

Rb (megohms) Rc2 (megohms)	Ebb = 100 Volts						Ebb = 150 Volts					
	0.100		0.270		0.470		0.100		0.270		0.470	
	0.220		0.680		1.20		0.270		0.820		1.50	
Rcf (megohms)	0.27	0.47	0.47	1.0	0.47	1.0	0.27	0.47	0.47	1.0	0.47	1.0
Rk (ohms)	820	820	2200	2200	3300	3300	560	560	1500	1500	2200	2200
Ib (ma)	0.75	0.75	0.273	0.273	0.164	0.164	1.13	1.13	0.42	0.42	0.247	0.247
Ic2 (ma)	0.292	0.292	0.102	0.102	0.062	0.062	0.41	0.41	0.143	0.143	0.083	0.083
Ec1 (volts)	-0.855	-0.855	-0.825	-0.825	-0.746	-0.746	-0.862	-0.862	-0.845	-0.845	-0.726	-0.726
Ec2 (volts)	35.8	35.8	31.4	31.4	25.5	25.5	39.3	39.3	32.8	32.8	25.6	25.6
Eb (volts)	25.0	25.0	26.3	26.3	22.9	22.9	37.0	37.0	36.7	36.7	34.0	34.0
Esig (volts, rms)	0.1	0.1	0.1	0.1	0.1	0.1	0.1	0.1	0.1	0.1	0.1	0.1
Eout (volts, rms)	8.2	9.0	9.5	11.8	9.2	11.7	11.5	12.5	13.2	15.5	13.0	16.7
Gain	82	90	95	118	92	117	115	125	132	155	130	167
% Distortion	2.8	3.8	2.5	3.0	3.1	2.3	1.5	2.2	2.4	2.4	3.7	3.0
Esig* (volts, rms)	0.23	0.22	0.15	0.16	0.12	0.14	0.20	0.18	0.16	0.16	0.11	0.14
Eout (volts, rms)	17.7	18.6	13.6	17.0	11.0	16.0	21.7	21.7	20.5	24.0	14.0	22.2
Gain	77	85	91	106	92	114	109	120	128	150	127	159
% Distortion	4.9	4.8	4.7	4.4	4.8	5.0	4.8	5.0	4.9	4.8	4.2	4.8

\* Maximum signal for 5% distortion or 1/8 microampere grid current.

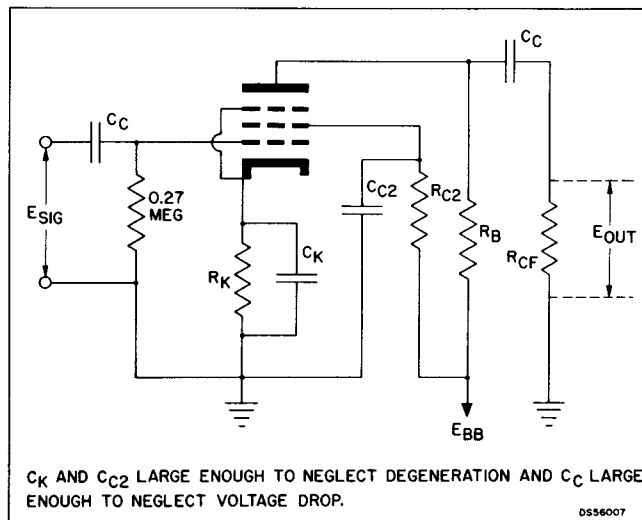

Resistance coupled amplifier circuit.

The information presented on this data sheet is furnished without assuming any obligation.

AVERAGE PLATE CHARACTERISTICS  
(PENTODE CONNECTED)

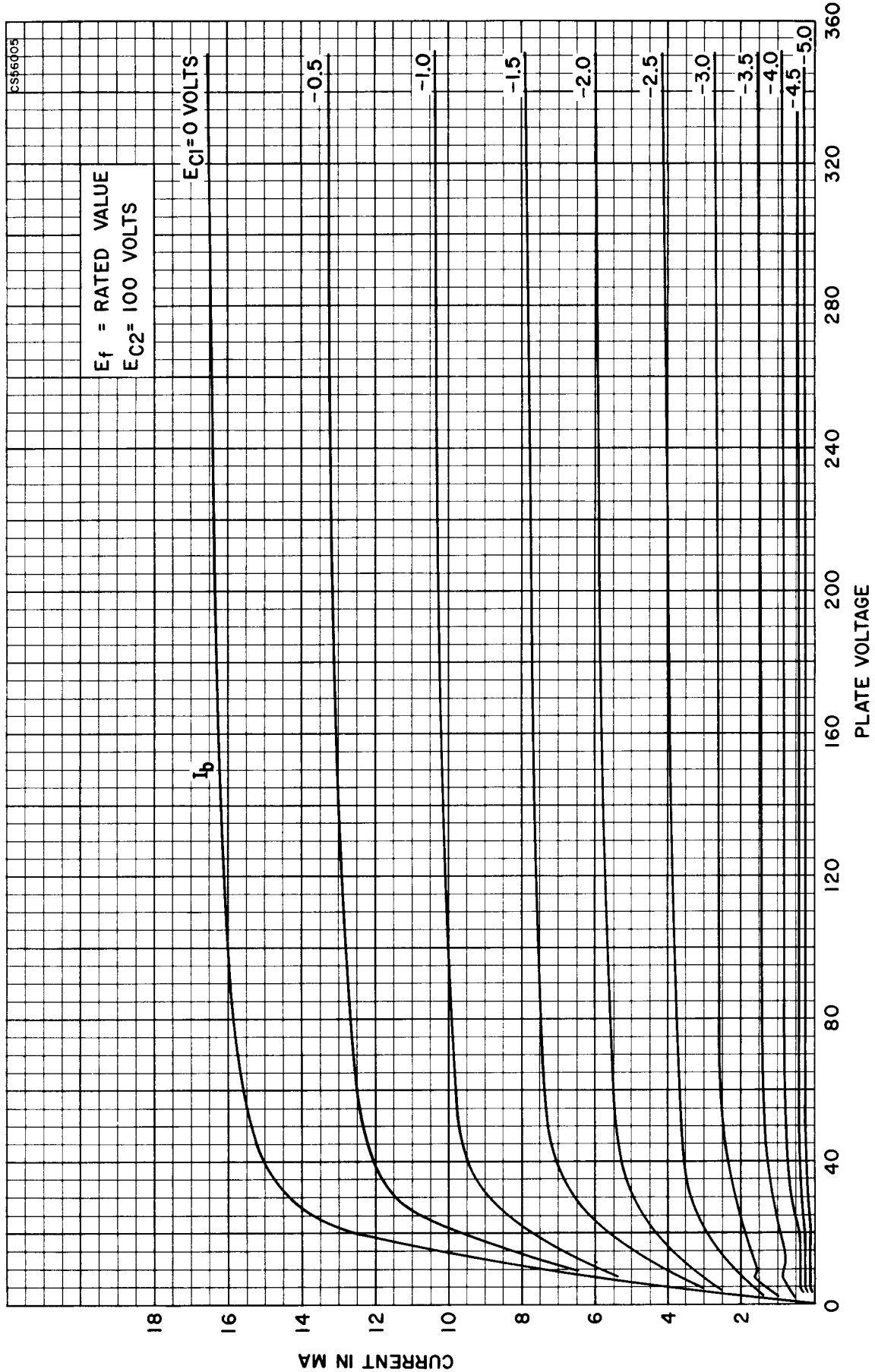

## AVERAGE PLATE CHARACTERISTICS (PENTODE CONNECTED)

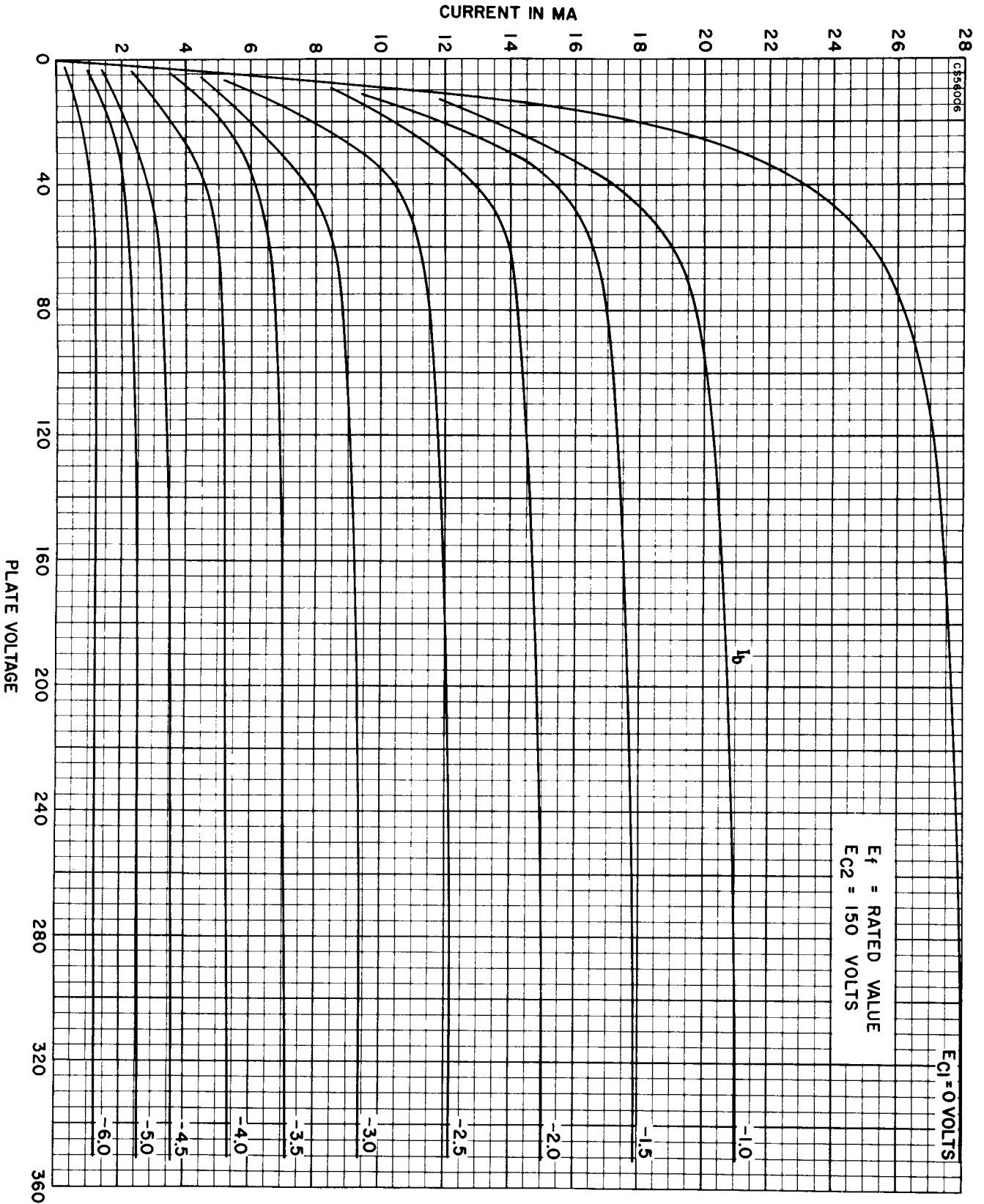

AVERAGE GRID No. 2 CHARACTERISTICS  
(PENTODE CONNECTED)

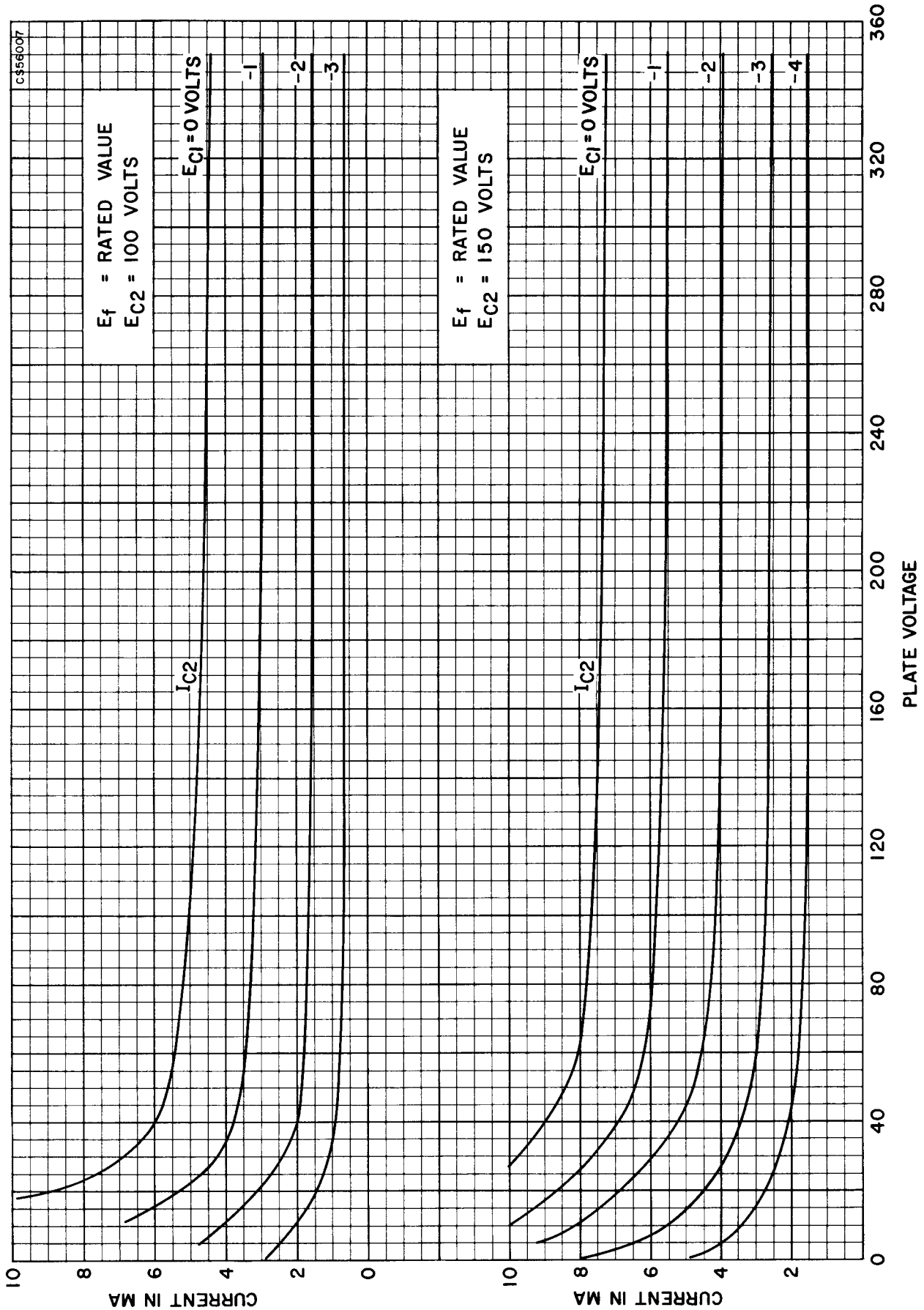

## AVERAGE PLATE CHARACTERISTICS (TRIODE CONNECTED)

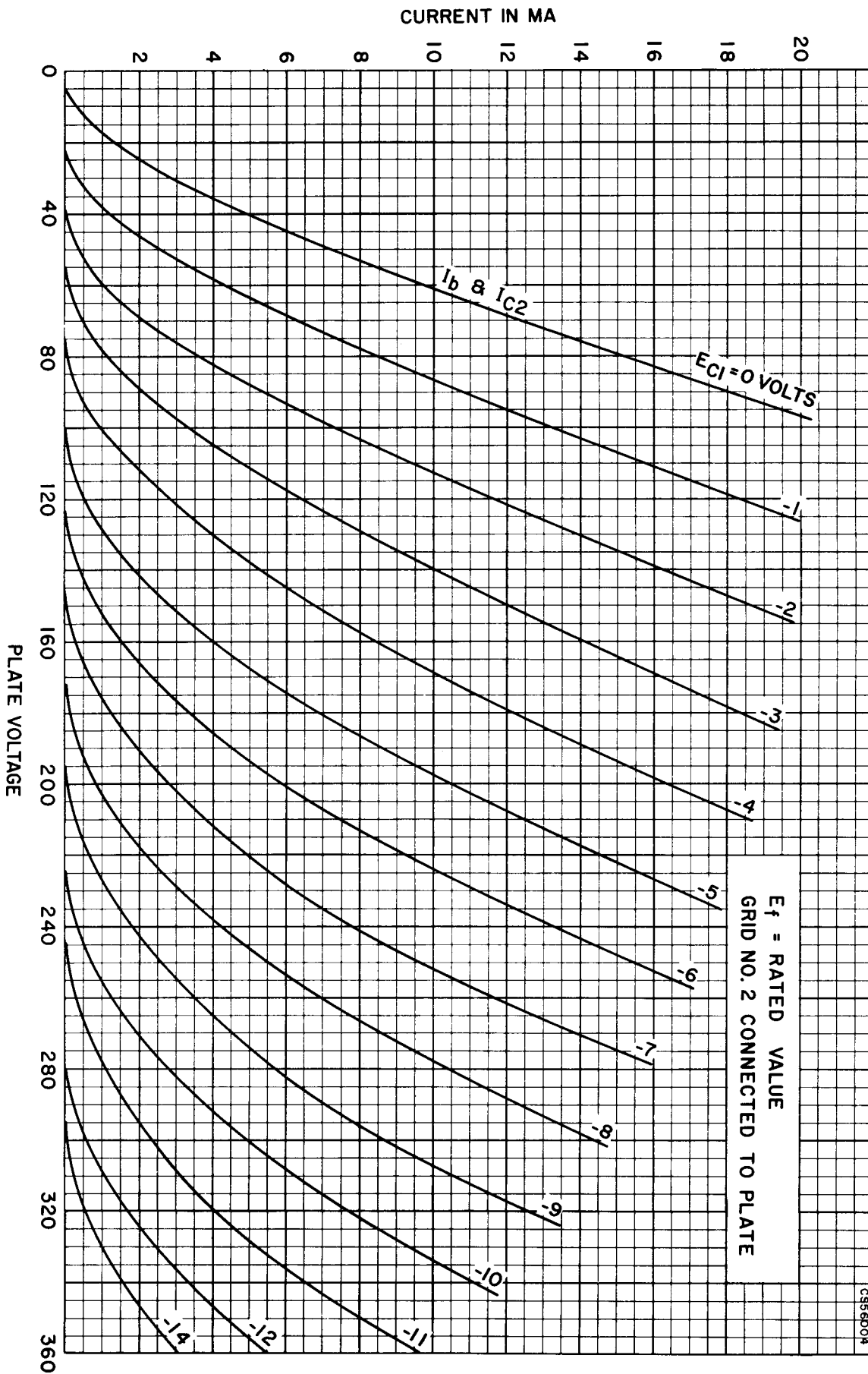



AVERAGE TRANSFER CHARACTERISTICS  
(PENTODE CONNECTED)

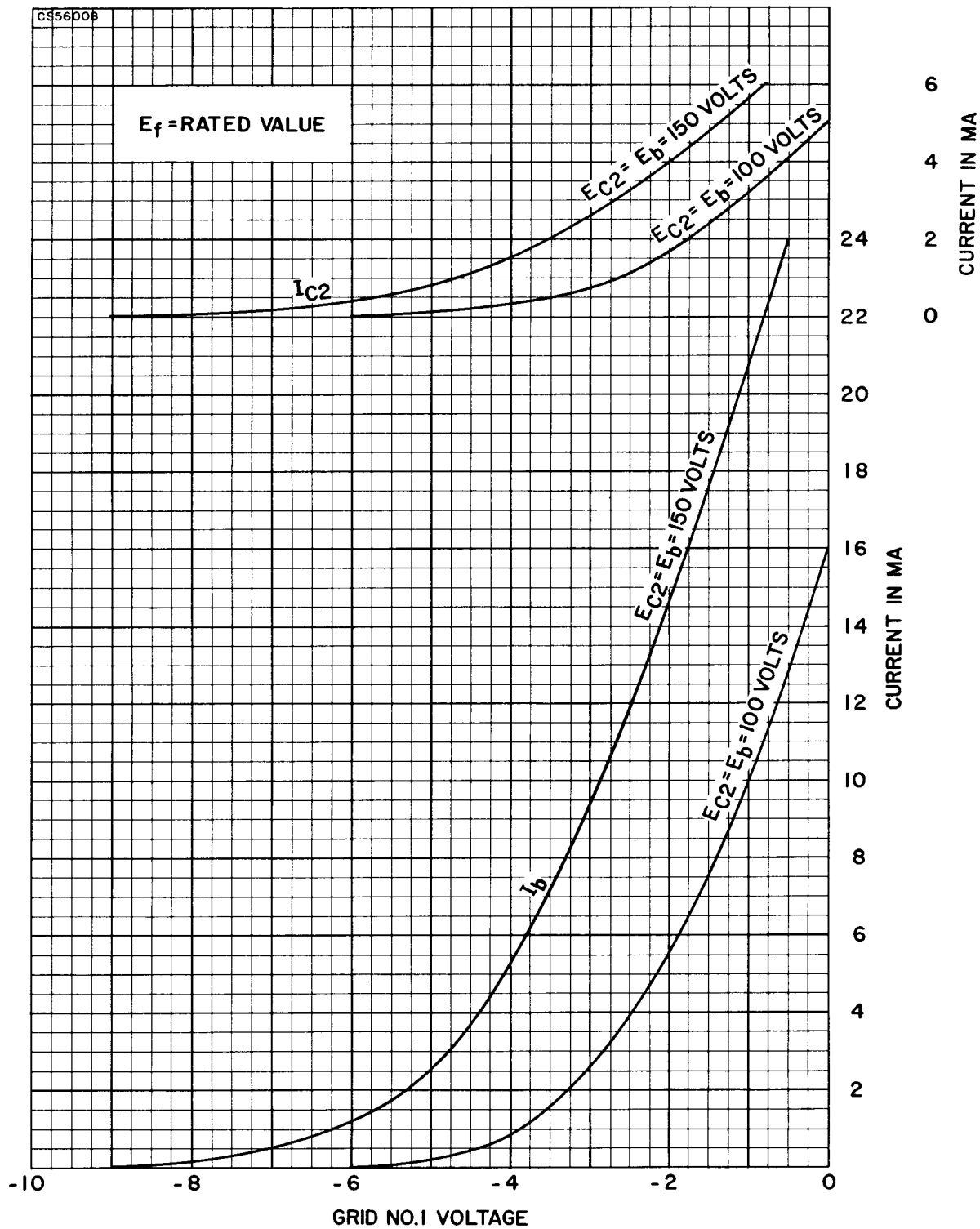

AVERAGE TRANSFER CHARACTERISTICS  
(PENTODE CONNECTED)

