



6DT6 - 3DT6 - 4DT6

PENTODE

FOR FM DETECTOR APPLICATIONS

6DT6
3DT6
4DT6
ET-T1313A
Page 1
1-57

DESCRIPTION AND RATING

The 6DT6 is a miniature sharp-cutoff dual-control pentode primarily intended for use as an FM detector in television receivers. It is also suitable for use in delay circuits, gain-controlled amplifier circuits, and mixer circuits.

As an FM detector, the 6DT6 performs the combined functions of limiter and detector when used in conjunction with suitable circuitry. It also exhibits high sensitivity, and is capable of providing high audio output voltage.

Except for heater ratings, the 3DT6 and 4DT6 are identical to the 6DT6. In addition, they incorporate a controlled heater warm-up characteristic, which makes them especially suited for use in television receivers that employ series-connected heaters.

GENERAL

ELECTRICAL

	3DT6	4DT6	6DT6
Cathode—Coated Unipotential			
Heater Voltage, AC or DC	3.15	4.2	6.3 Volts
Heater Current	0.6	0.45	0.3 Amperes
Heater Warm-up Time*	11	11	... Seconds
Direct Interelectrode Capacitances, approximate†			
Grid-Number 1 to Plate			0.02 μ f
Grid-Number 3 to Plate			1.4 μ f
Grid-Number 1 to All Except Plate			5.8 μ f
Grid-Number 3 to All			6.1 μ f
Grid-Number 1 to Grid-Number 3			0.1 μ f

MECHANICAL

Mounting Position—Any
Envelope—T-5½, Glass
Base—E7-1, Miniature Button 7-Pin

MAXIMUM RATINGS

FM DETECTOR SERVICE—DESIGN-CENTER VALUES

Plate Voltage	300 Volts
Suppressor Voltage	25 Volts
Screen-Supply Voltage	300 Volts
Screen Voltage—See Screen Rating Chart	
Positive DC Grid-Number 1 Voltage	0 Volts
Plate Dissipation	1.5 Watts
Screen Dissipation	1.0 Watts
Heater-Cathode Voltage	
Heater Positive with Respect to Cathode	
DC Component	100 Volts
Total DC and Peak	200 Volts
Heater Negative with Respect to Cathode	
Total DC and Peak	200 Volts
Grid-Number 1 Circuit Resistance	
With Fixed Bias	0.25 Megohms
With Cathode Bias	0.5 Megohms

BASING DIAGRAM

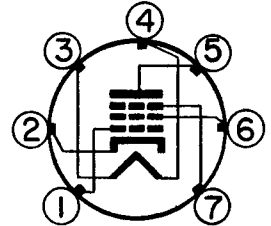

RETMA 7EN

TERMINAL CONNECTIONS

- Pin 1—Grid Number 1
- Pin 2—Cathode and Internal Shield
- Pin 3—Heater
- Pin 4—Heater
- Pin 5—Plate
- Pin 6—Grid Number 2 (Screen)
- Pin 7—Grid Number 3 (Suppressor)

PHYSICAL DIMENSIONS

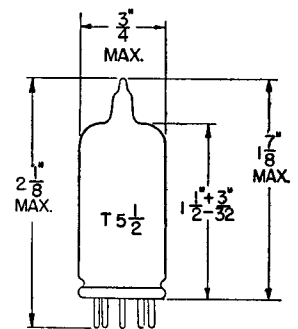

RETMA 5-2

GENERAL ELECTRIC

Supersedes ET-T1313, dated 2-56

CHARACTERISTICS AND TYPICAL OPERATION

CLASS A₁ AMPLIFIER

Plate Voltage.....	150	Volts
Suppressor Voltage.....	0	Volts
Screen Voltage.....	100	Volts
Cathode-Bias Resistor.....	560	Ohms
Plate Resistance, approximate.....	0.15	Megohms
Grid-Number 1 Transconductance.....	800	Micromhos
Grid-Number 3 Transconductance.....	515	Micromhos
Plate Current.....	1.1	Milliamperes
Screen Current.....	2.1	Milliamperes
Grid-Number 1 Voltage, approximate I _b = 10 Microamperes.....	-4.5	Volts
Grid-Number 3 Voltage, approximate I _b = 10 Microamperes.....	-3.5	Volts

4.5-Megacycle FM Detector—See Circuit Diagram

RMS Input Signal to Grid to Driver Tube.....	15	200	500	Millivolts
Plate Supply Voltage.....	250	250	250	Volts
Suppressor Voltage (Obtained from a 560,000-ohm resistor).....	-5.0	-6.0	-6.4	Volts
Screen Voltage.....	100	100	100	Volts
Cathode-Bias Resistor.....	560	560	560	Ohms
Plate Load Resistor.....	0.27	0.27	0.27	Megohms
Plate Current.....	0.23	0.22	0.21	Milliamperes
Screen Current.....	3.4	5.5	6.0	Milliamperes
Grid-Number 1 Current.....	0.013	0.6	0.8	Milliamperes
Bandwidth				
For a Total Harmonic Distortion of 10 Percent.....	65	120	118	Kilocycles
AM Rejection [‡] , approximate.....	33	29	28	Decibels
RMS Audio Output Voltage, approximate				
With ± 7.5 -kc Deviation from Mean Value of 4.5 Megacycles.....	5.5	6.5	7.5	Volts
With ± 25 -kc Deviation from Mean Value of 4.5 Megacycles.....	17	21	23	Volts
Total Harmonic Distortion, approximate				
With ± 25 -kc Deviation from Mean Value of 4.5 Megacycles.....	2	3	4	Percent
Sensitivity				
With ± 7.5 -kc Deviation from Mean Value of 4.5 Megacycles.....	.5§			Millivolts
With ± 25 -kc Deviation from Mean Value of 4.5 Megacycles.....	15§			Millivolts

* The time required for the voltage across the heater to reach 80 percent of its rated value after applying 4 times rated heater voltage to a circuit consisting of the tube heater in series with a resistance equal to 3 times the rated heater voltage divided by the rated heater current.

† With external shield (RETMA 316) connected to cathode.

‡ Ratio of the audio output voltage produced by 30-percent amplitude modulation of the 4.5-megacycle carrier frequency to the audio output voltage produced by ± 25 -kilocycle deviation from the 4.5-megacycle carrier frequency, with a modulating frequency of 400 cps in both cases.

§ Signal level at which detector circuit will handle the indicated deviation in frequency from the mean value of 4.5 megacycles before distortion occurs.

LOCKED-OSCILLATOR, QUADRATURE-GRID DETECTOR CIRCUIT UTILIZING TYPE 6DT6 OR 3DT6

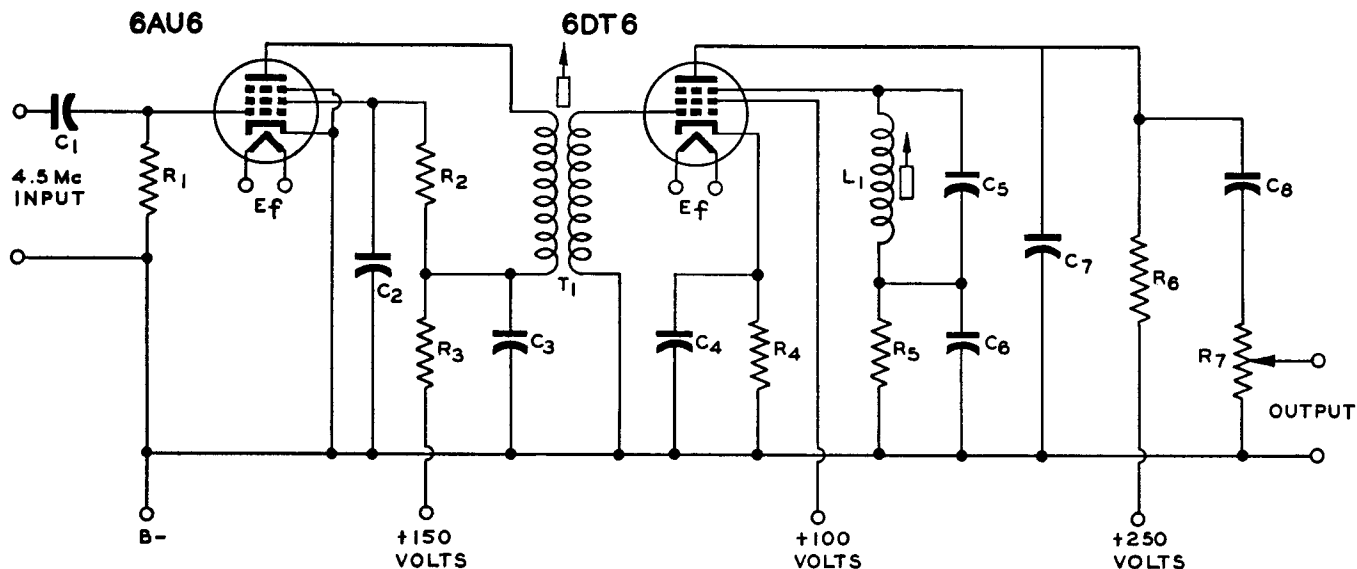

C₁ - 47 μ f, 400 VOLTS
 C₂ C₃ - 0.01 μ f, 400VOLTS
 C₄ - 0.01 μ f, 200 VOLTS
 C₅ - 18 μ f, 200 VOLTS
 C₆ - 0.05 μ f, 200 VOLTS
 C₇ - 100 TO 1000 μ f,
 400 VOLTS
 C₈ - 0.01 μ f, 400 VOLTS

L₁ - SLUG-TUNED INDUCTOR
 WITH Q OF 50 AND
 TUNEABLE TO 4.5-MC
 R₁ - 100000 OHMS, 0.5 WATT
 R₂ - 12000 OHMS, 0.5 WATT
 R₃ - 1000 OHMS, 0.5 WATT
 R₄ - 560 OHMS, 0.5 WATT
 R₅ - 560000 OHMS, 0.5 WATT

R₆ - 270000 OHMS, 0.5 WATT
 R₇ - 0.5 MEGOHM POTENTIOMETER
 T₁ - SLUG-TUNED, BIFILAR
 WOUND IF TRANSFORMER
 WITH RATIO OF 1:1.5,
 Q > 60, AND TUNEABLE
 TO 4.5-MC WITH TUBE AND
 WIRING CAPACITANCE

RECOMMENDED ALIGNMENT PROCEDURE

1. Feed a 500-millivolt, 4.5-mc, 400-cps FM-modulated (± 25 -kc deviation) signal to the input of the driver tube.
2. Adjust L₁ for maximum undistorted sound output. Since several maxima may occur during this adjustment, it is important to select the proper one. This is the higher frequency peak and coincides with maximum voltage drop across R₅.
3. Reduce the level of the 4.5-mc signal to 5 millivolts RMS.
4. Using an oscilloscope, adjust T₁ for a centered discriminator characteristic with oscillation beats at the edges. Alternatively, T₁ may be adjusted for maximum d-c voltage across R₅.
5. Repeat steps 1 through 4 as necessary to assure accurate alignment.

AVERAGE PLATE CHARACTERISTICS

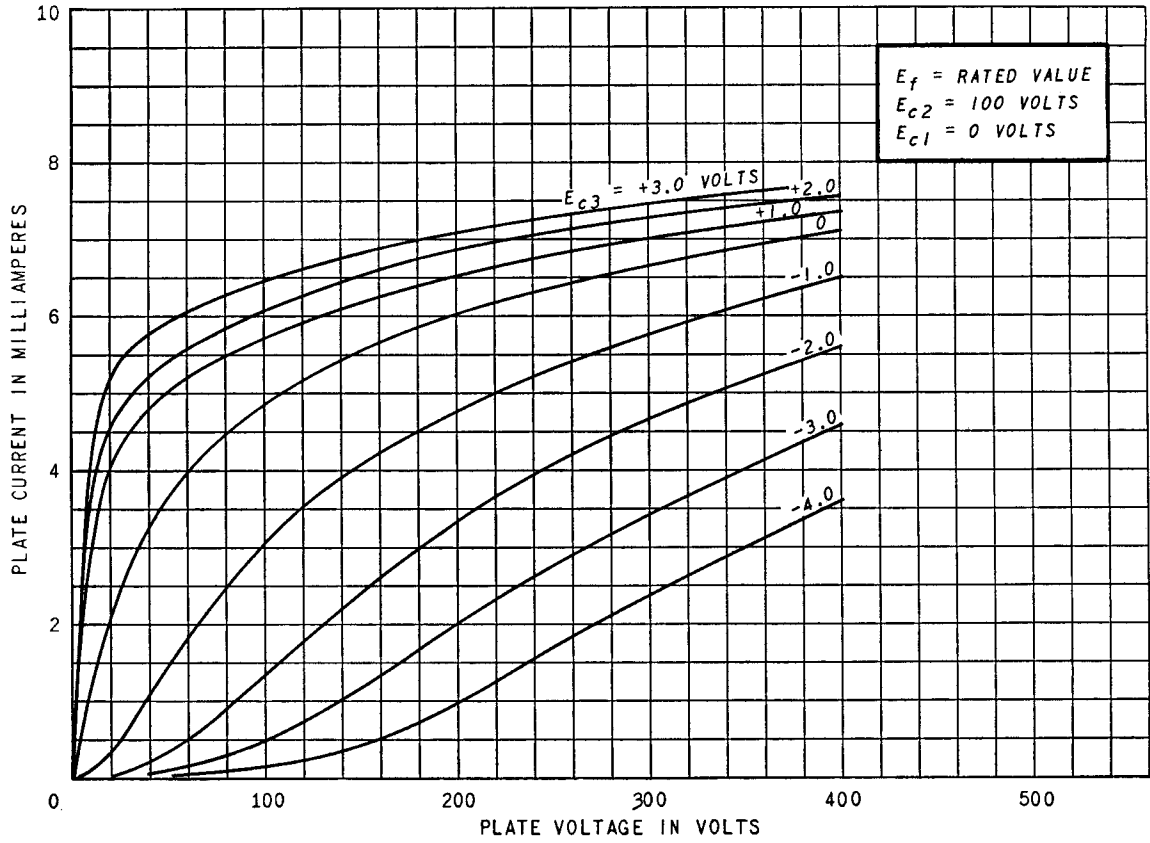

AVERAGE PLATE CHARACTERISTICS

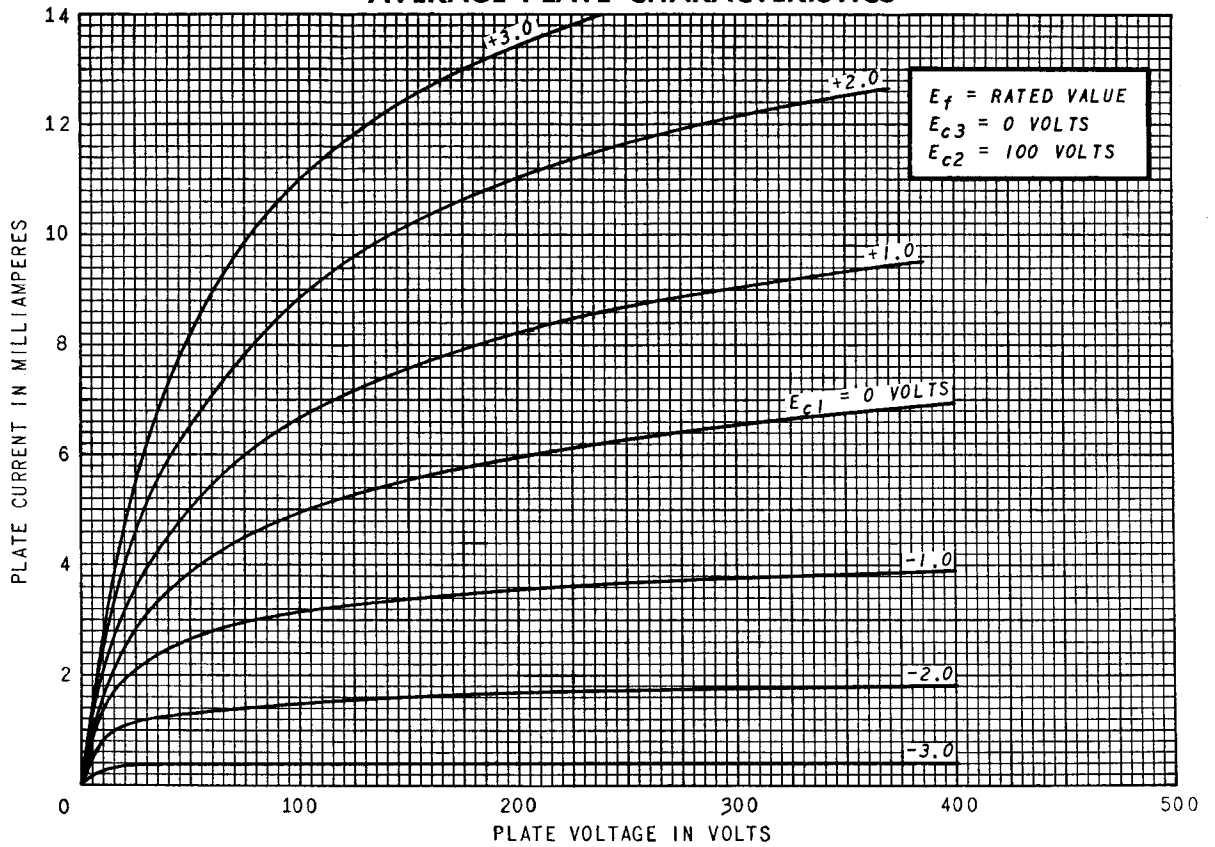

AVERAGE CHARACTERISTICS

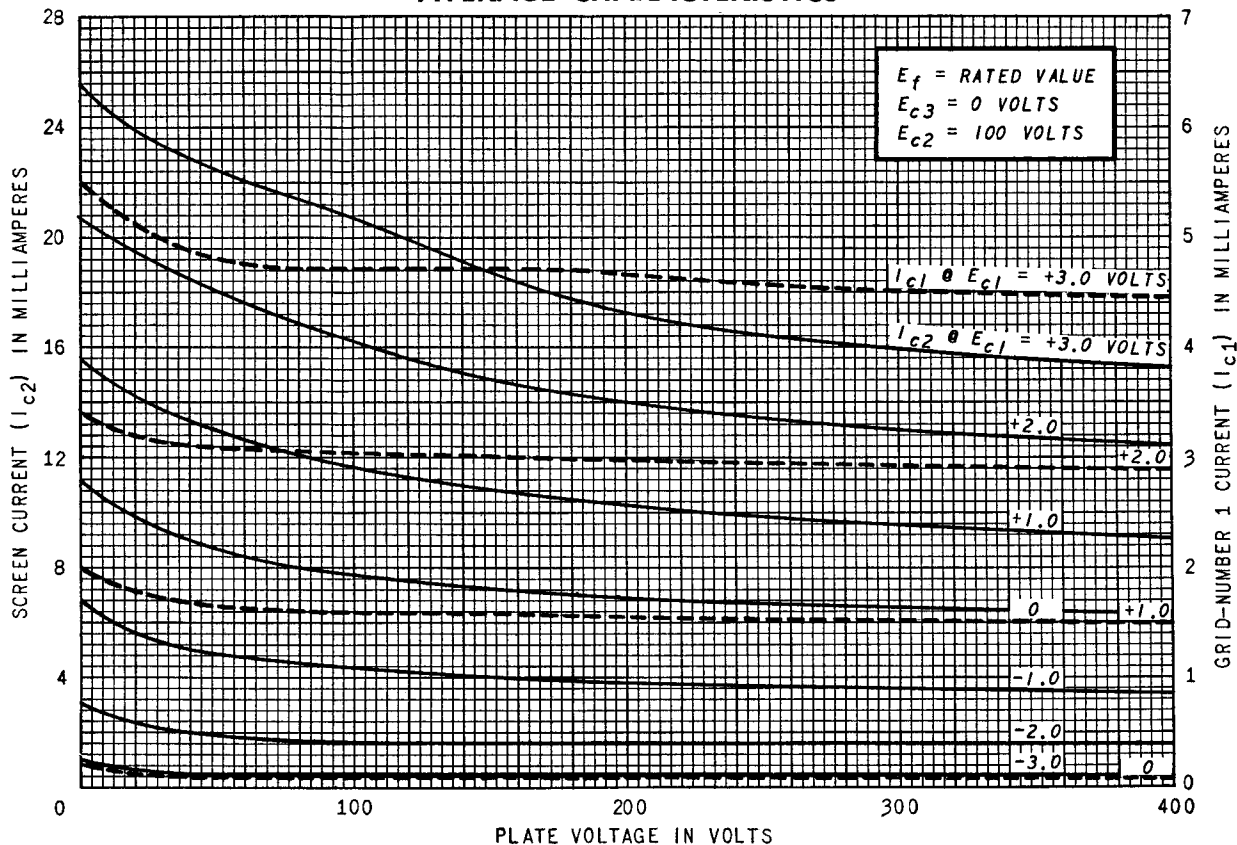

AVERAGE CHARACTERISTICS

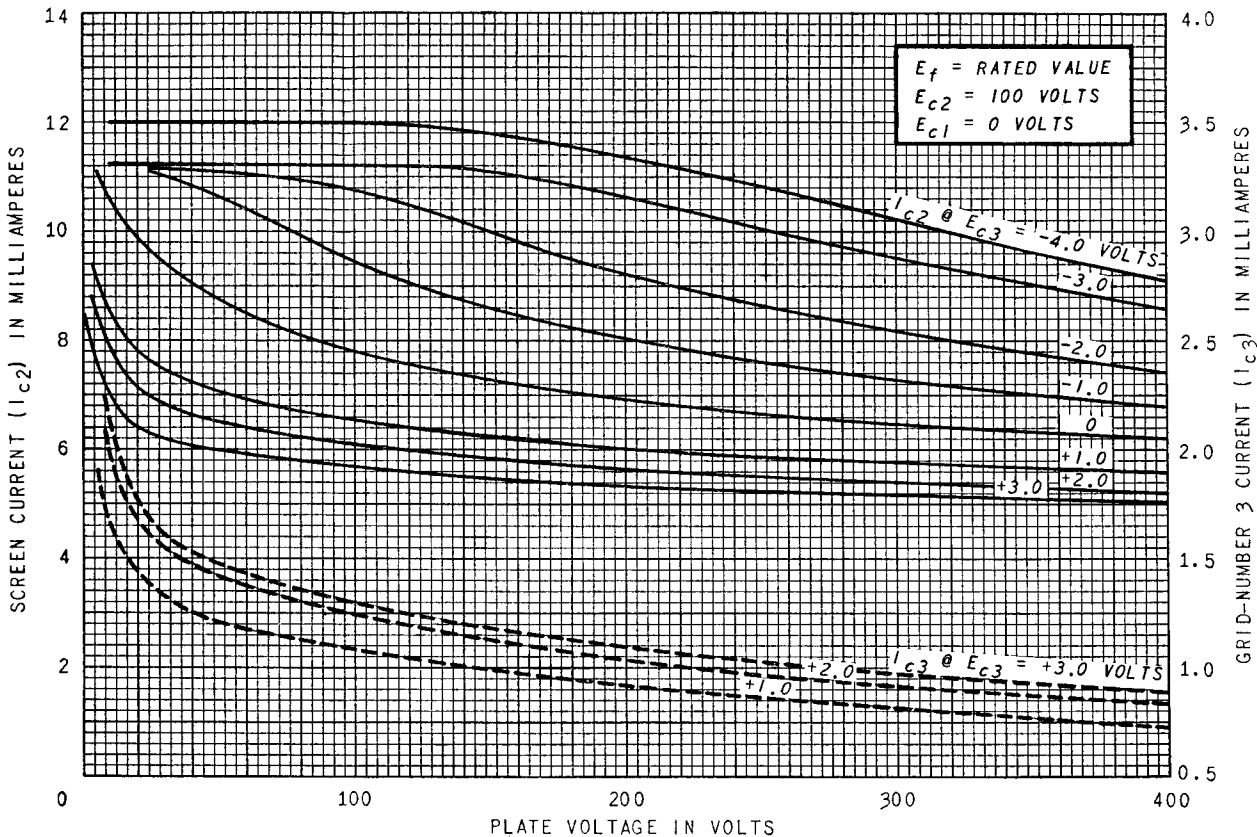

AVERAGE TRANSFER CHARACTERISTICS

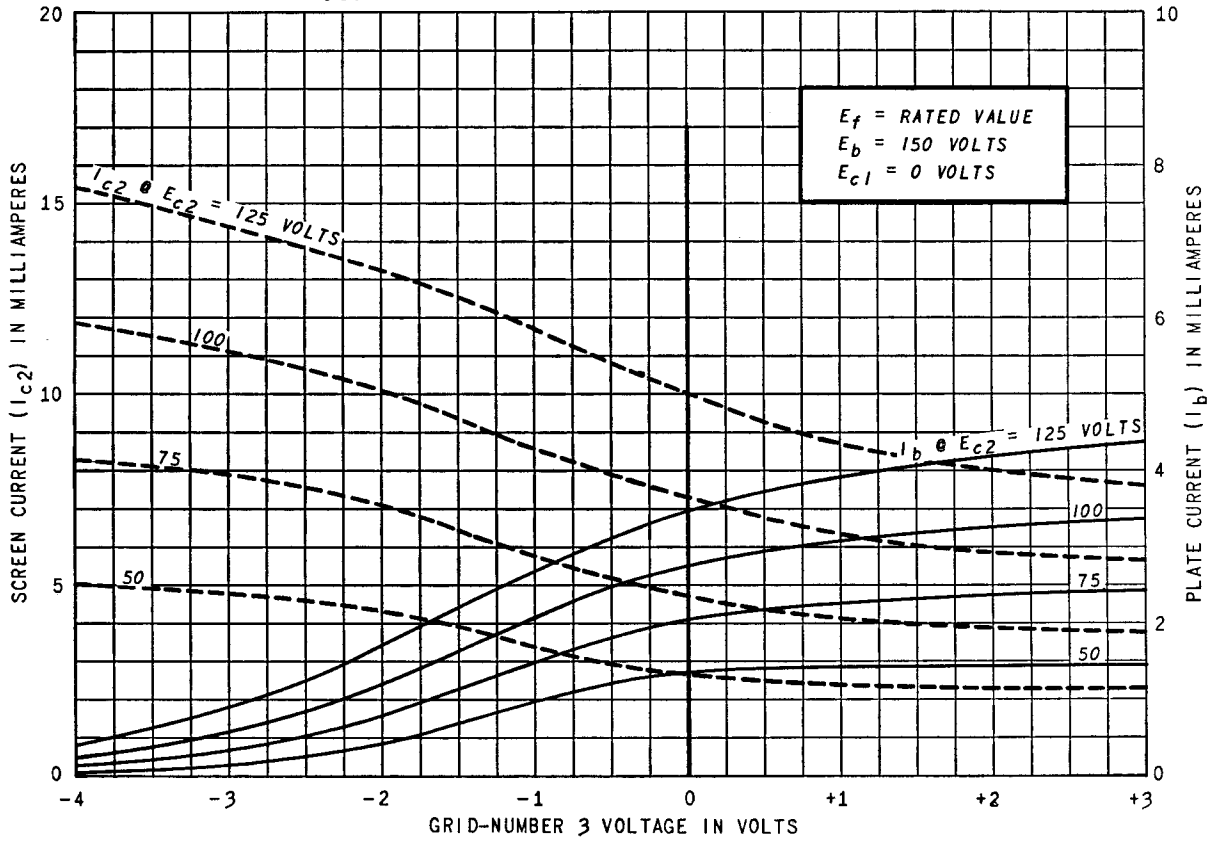

AVERAGE TRANSFER CHARACTERISTICS

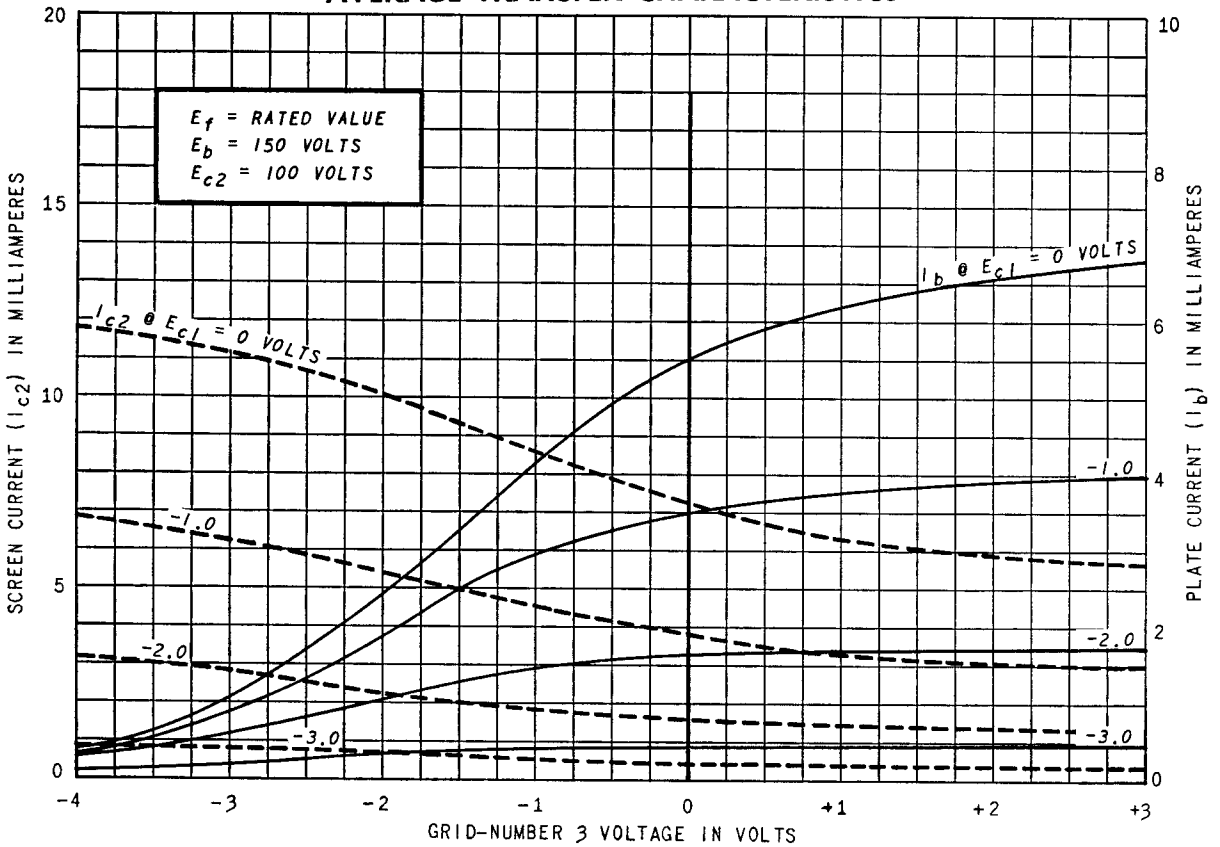

AVERAGE TRANSFER CHARACTERISTICS

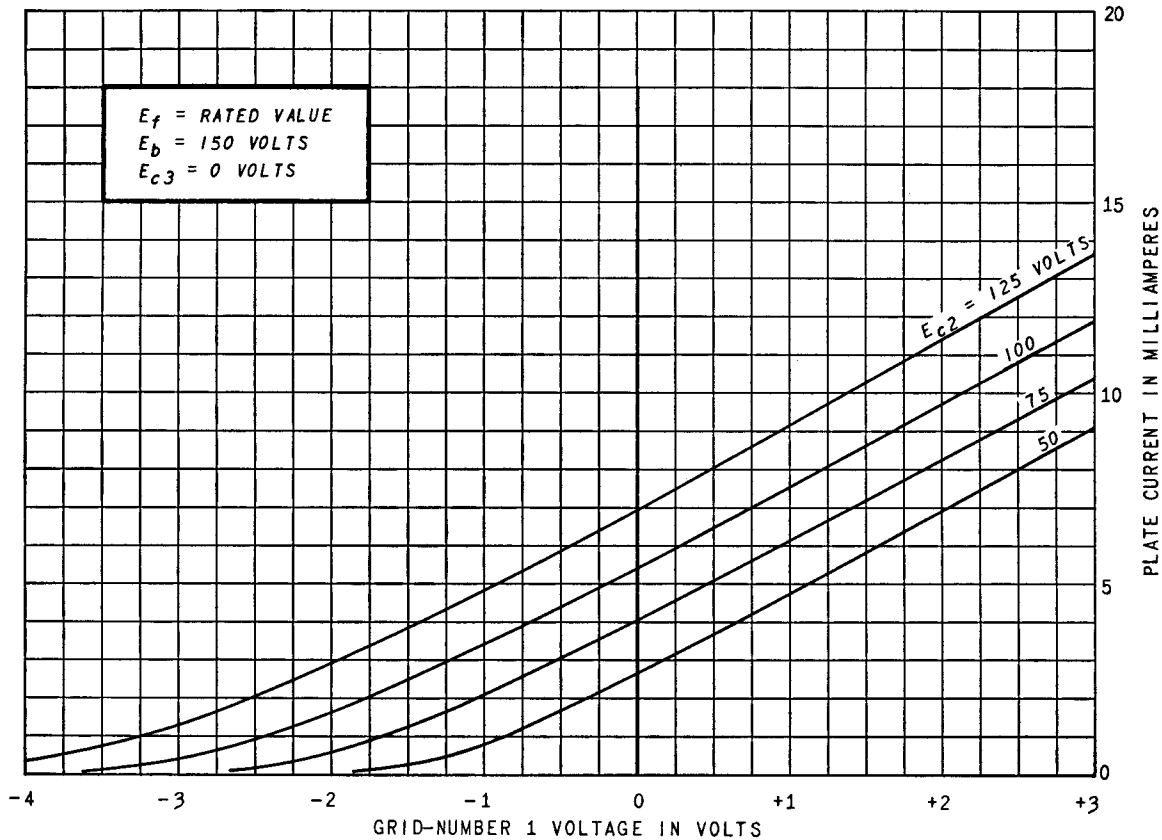

AVERAGE TRANSFER CHARACTERISTICS

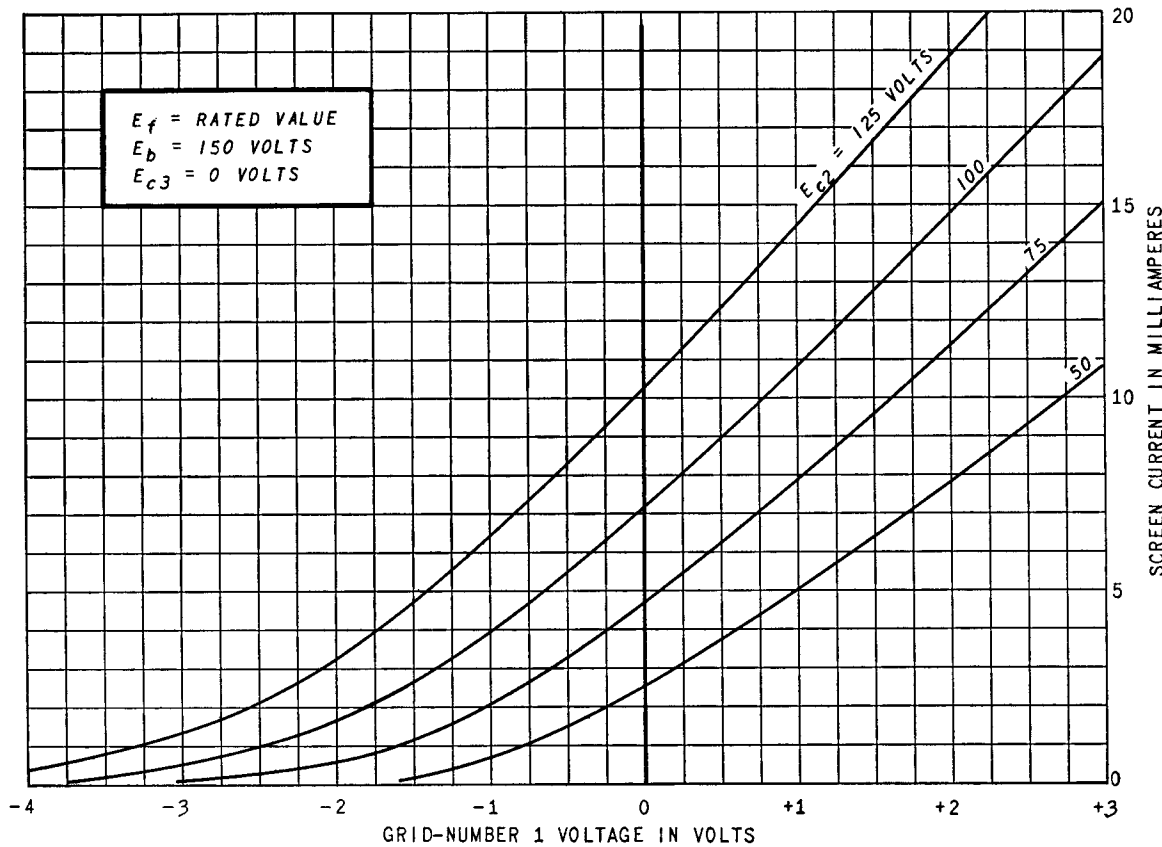

SCREEN RATING CHART

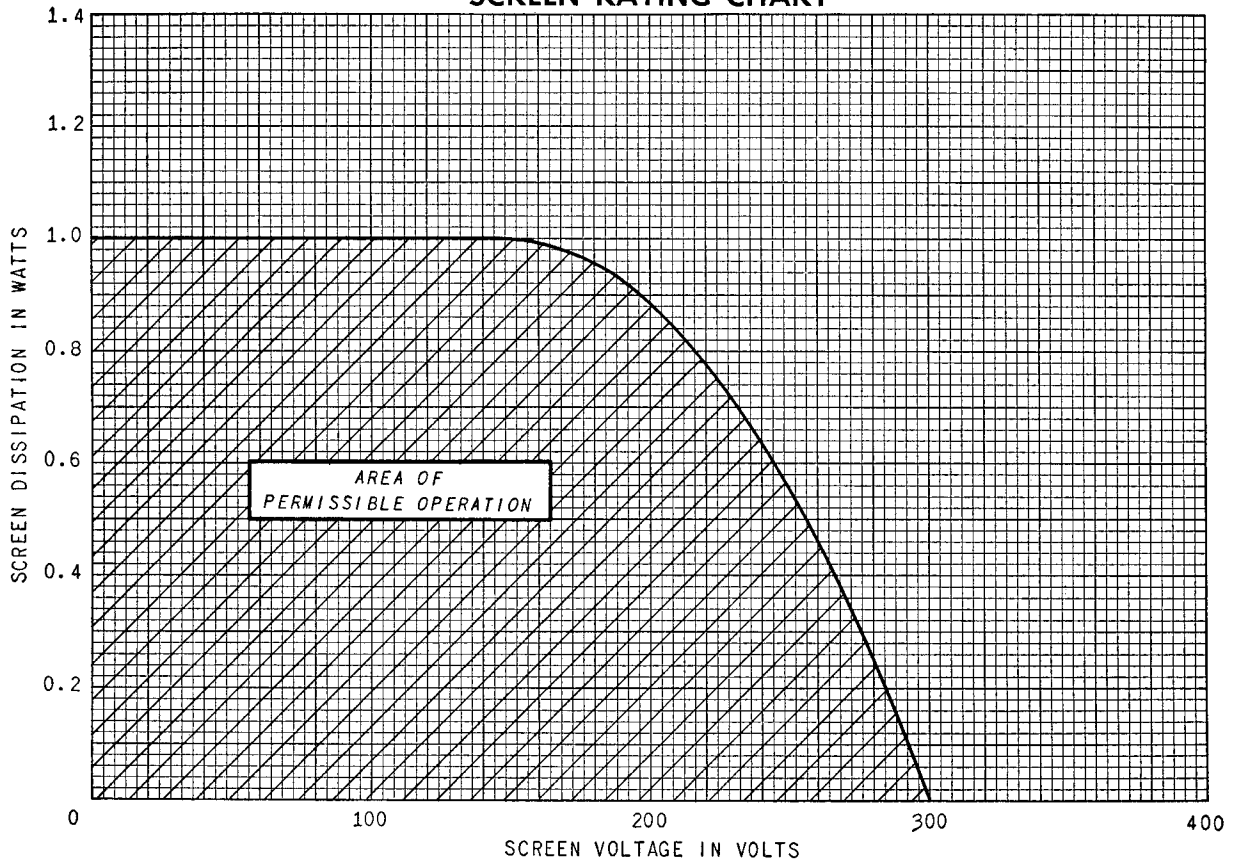

ELECTRONIC COMPONENTS DIVISION
GENERAL  **ELECTRIC**
Schenectady 5, N. Y.