



6BX7-GT Description and Rating

TWIN TRIODE

GENERAL DESCRIPTION

Principal Application: The 6BX7-GT is a high-transconductance twin triode designed primarily for use as a combined vertical deflection amplifier and vertical oscillator in television receivers. Each section of the 6BX7-GT features high plate current

Cathodes Coated Unipotential
 Heater Voltage (A-C or D-C) 6.3 Volts
 Heater Current 1.5 Amperes
 Envelope T-9, Glass
 Base 8B-58, Short Intermediate Shell Octal 8-Pin
 Mounting Position Any

at low plate voltages and is capable of withstanding the high pulse voltages normally encountered in this application. The 6BX7-GT, when operated from relatively low plate supply voltages, is capable of deflecting fully large-deflection-angle picture tubes.

Direct Interelectrode Capacitances: #

	Section 1	Section 2	
Grid to Plate	4.2	4.0	$\mu\mu\text{f}$
Input	4.4	4.8	$\mu\mu\text{f}$
Output	1.1	1.2	$\mu\mu\text{f}$
Grid to Grid	0.11		$\mu\mu\text{f}$
Plate to Plate	1.5		$\mu\mu\text{f}$

PHYSICAL DIMENSIONS

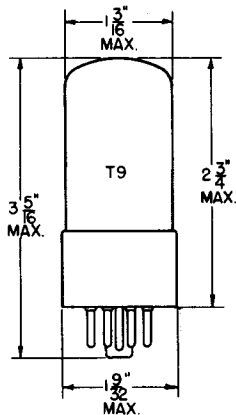

RTMA 9-41

TERMINAL CONNECTIONS

- Pin 1 - Grid (Section 2)
- Pin 2 - Plate (Section 2)
- Pin 3 - Cathode (Section 2)
- Pin 4 - Grid (Section 1)
- Pin 5 - Plate (Section 1)
- Pin 6 - Cathode (Section 1)
- Pin 7 - Heater
- Pin 8 - Heater

BASING DIAGRAM

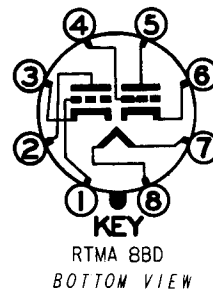

DESIGN CENTER VALUES * (EACH SECTION)

	Vertical Deflection Amplifier and Oscillator **	
D-C Plate Voltage	500	Volts
Peak Positive Pulse Plate Voltage (Absolute Maximum)	2000	Volts
Positive D-C Grid Voltage	0	Volts
Peak Negative Grid Voltage	-500	Volts
Plate Dissipation (Each Plate) **	10	Watts
Plate Dissipation (Both Plates) **	12	Watts
Average Cathode Current	60	Milliamperes
Peak Cathode Current	180	Milliamperes
Heater-Cathode Voltage:		
Heater Negative with Respect to Cathode		
Total D-C and Peak	200	Volts
Heater Positive with Respect to Cathode		
D-C Component	100	Volts
Total D-C and Peak	200	Volts
Grid Circuit Resistance	2.2	Megohms

CHARACTERISTICS AND TYPICAL OPERATION

AVERAGE CHARACTERISTICS (EACH SECTION)

Plate Voltage	100	250	Volts
Cathode Bias Resistor	0	390	Ohms
Amplification Factor	---	10	
Plate Resistance (Approx)	---	1300	Ohms
Transconductance	---	7600	Micromhos
Plate Current	80	42	Milliamperes
Grid Voltage (Approx) for $I_b = 50$ Microamperes	---	-40	Volts

VERTICAL DEFLECTION AMPLIFIER [†] (SECTION 2) ^{††}

Plate Voltage	170	Volts
Cathode Bias Resistor ‡	170	Ohms
Grid Input Voltage: (Approx)		
Sawtooth Component	41	Volts
Negative Peaking Component	70	Volts
D-C Cathode Current	24	Milliamperes
Peak Cathode Current	65	Milliamperes
Plate Output Voltage: (Approx)		
Sawtooth Component	160	Volts
Peak Positive Pulse Component	840	Volts

Without external shield

For operation in a 525-line, 30-frame television system as described in "Standards of Good Engineering Practice for Television Stations", Federal Communications Commission. The duration of the voltage pulse must not exceed 15-percent of one scanning cycle.

* All maximum ratings are based on the RTMA system of Design-Center Maximums except where absolute maximum is specified. The absolute maximum ratings represent limiting values beyond which the serviceability of the tube may be impaired from the viewpoint of life and satisfactory performance. Equipment incorporating this tube must be so designed that the absolute maximum values will never be exceeded under any usual condition of supply-voltage variation, manufacturing variation (including components) in the equipment, and/or control adjustment.

** An adequate cathode bias resistor or other suitable means is required to protect the tube in the absence of excitation.

† For use in conjunction with a 70-degree picture tube operating at an anode voltage of 14 kilovolts

†† When the 6BX7-GT is operated as a combined vertical deflection amplifier and oscillator, it is recommended that section 1 (pins 4, 5, and 6) be used as the oscillator.

‡ Typical value of total cathode resistance for optimum linearity

TYPICAL WAVEFORMS OF VERTICAL DEFLECTION AMPLIFIER

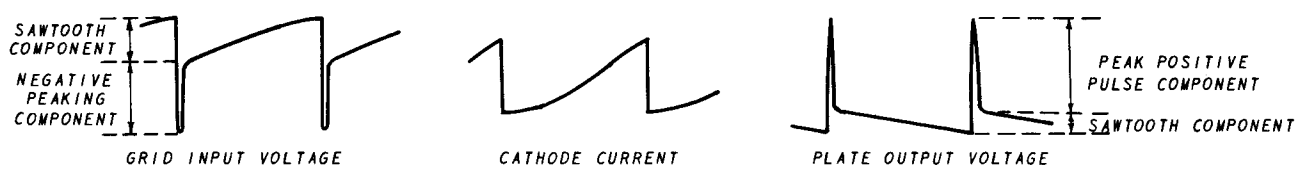

AVERAGE PLATE CHARACTERISTICS

EACH SECTION

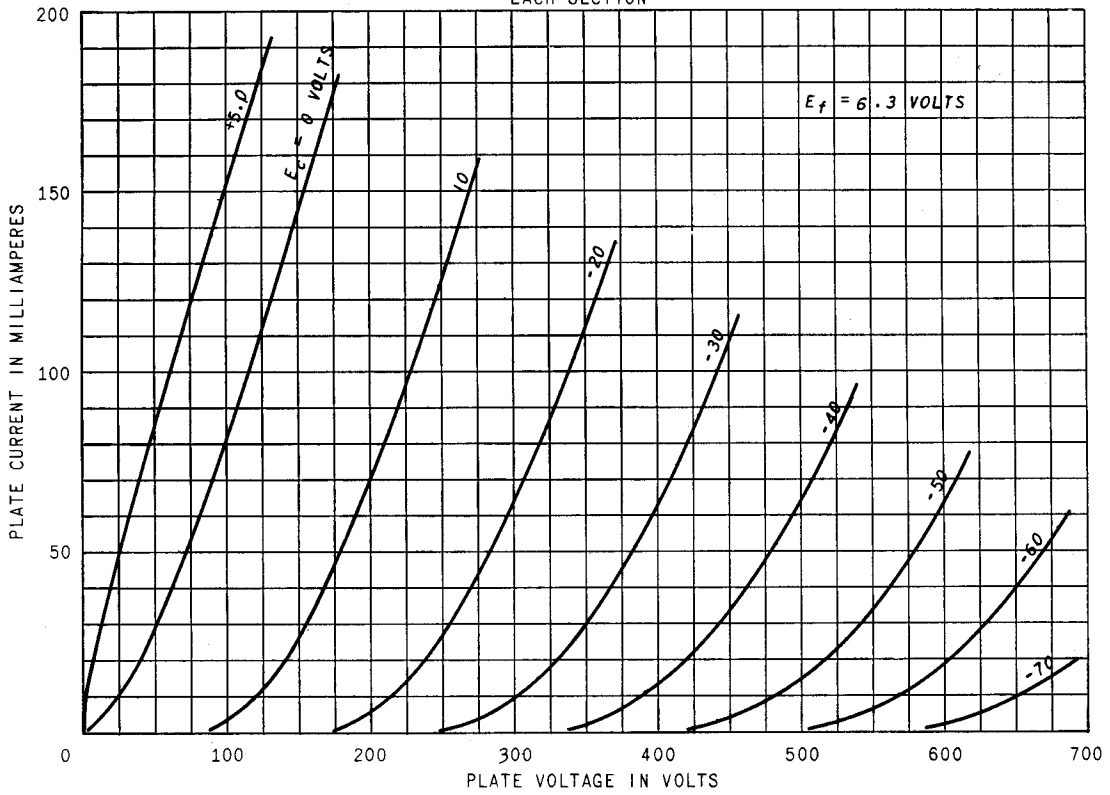

AVERAGE CHARACTERISTICS

EACH SECTION

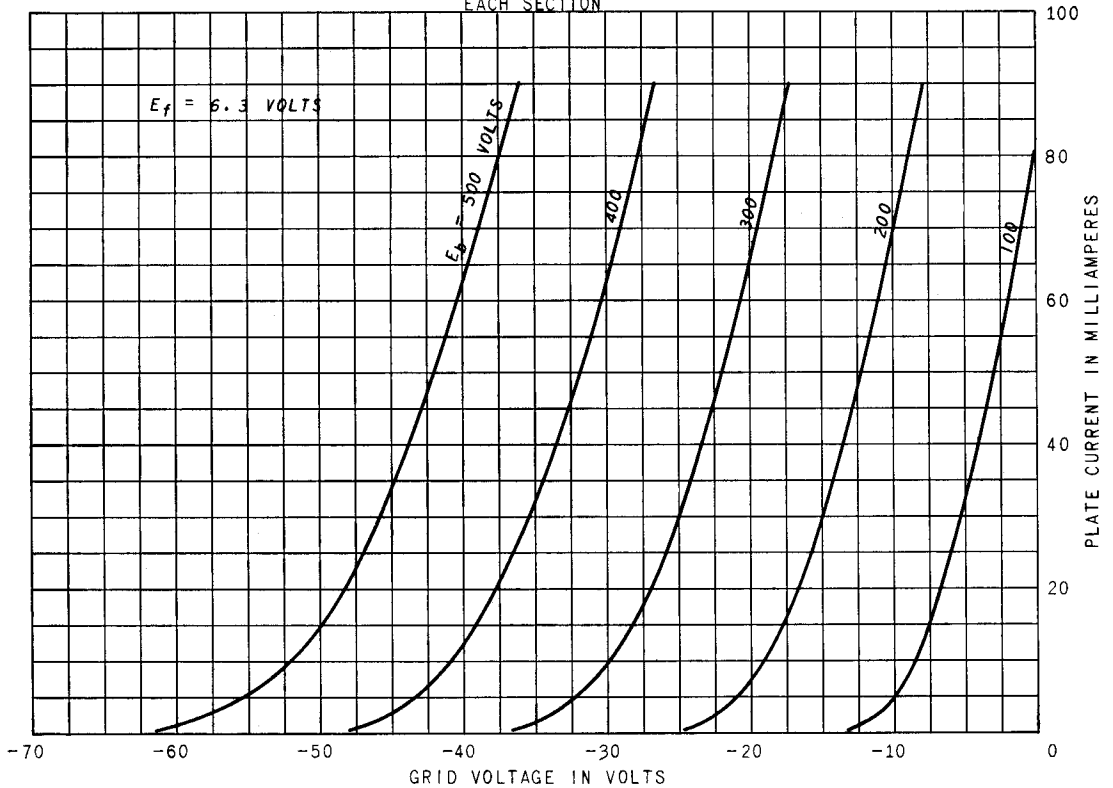

AVERAGE PLATE CHARACTERISTICS

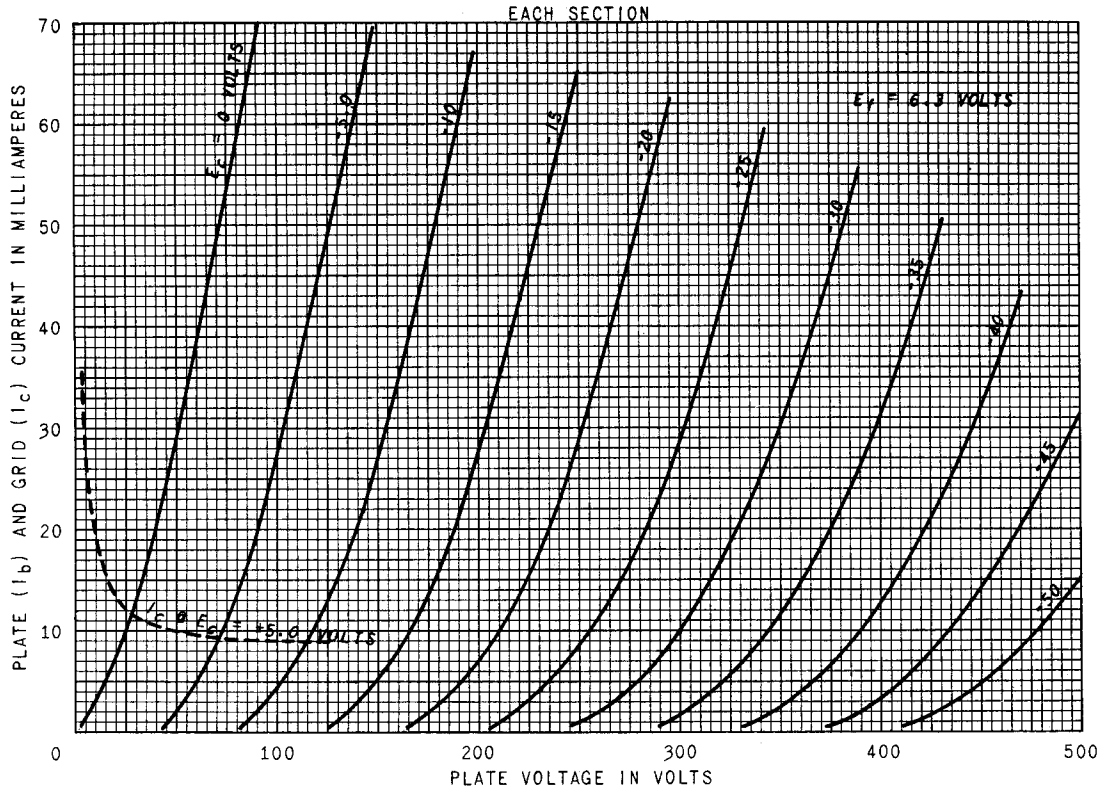

TYPICAL VERTICAL DEFLECTION CIRCUIT USING THE 6BX7-GT

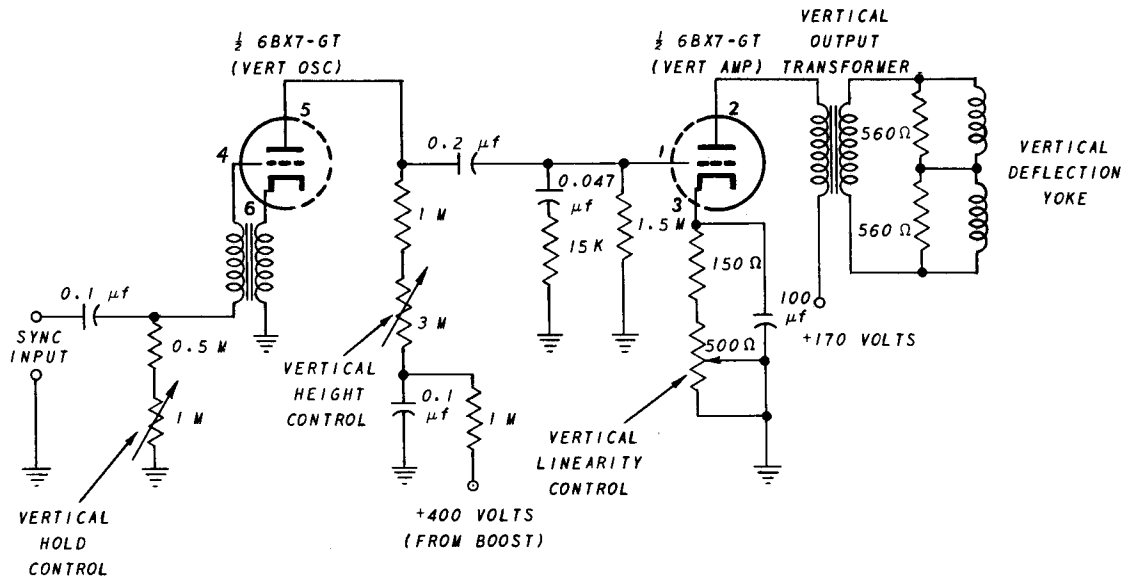

Circuits shown herein are examples of possible tube applications. The description and illustration of them does not convey to the purchaser of tubes any license under patent claims of General Electric Company.

Tube Department

GENERAL  ELECTRIC

Schenectady, N. Y.