



5690

5690
SPECIAL RED
TUBE

FULL-WAVE VACUUM RECTIFIER

Intended for critical industrial and aircraft applications where 10,000-hour life, extreme uniformity, rigid construction, and exceptional stability are paramount.

GENERAL DATA

Electrical:

Heaters, Pure Tungsten, for Unipotential Cathodes:			
Of Units 1 & 2 connected in	Series	Parallel	
Voltage	12.6 ± 5%*	6.3 ± 5%*	volts
Current	1.2	2.4	amp

Mechanical:

Mounting Position	Any
Maximum Overall Length	4-1/4"
Maximum Seated Length	3-11/16"
Maximum Diameter	1-23/32"
Bulb	T-12
Base	Short Jumbo-Shell Octal 8-Pin, Non Hygroscopic (JETEC No.B8-71)

BOTTOM VIEW

- Pin 1: Heater of Unit No.2
- Pin 2: Heater of Unit No.2
- Pin 3: Plate of Unit No.2
- Pin 4: Cathode of Unit No.2

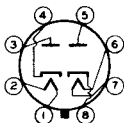

- Pin 5: Plate of Unit No.1
- Pin 6: Heater of Unit No.1
- Pin 7: Heater of Unit No.1
- Pin 8: Cathode of Unit No.1

RECTIFIER

Maximum Ratings, Absolute Values: For supply frequency of 60 cps

	For Altitudes up to 40000 Feet
PEAK INVERSE PLATE VOLTAGE	1120 max. volts
PEAK VOLTAGE BETWEEN PLATE OF UNIT No.1 AND PLATE OF UNIT No.2	1120 max. volts
PEAK PLATE CURRENT PER PLATE	375 max. ma
AC PLATE SUPPLY VOLTAGE (RMS) PER PLATE	See Rating Chart I
DC OUTPUT CURRENT PER PLATE	See Rating Chart I

HOT-SWITCHING CURRENT:

Even occasional hot-switching with capacitor-input circuits permits the flow of plate currents having magnitudes which can adversely affect the life and reliability of tubes designed for life values in the order of 10000 hours. If capacitor-input circuits are to be used, protect the circuits against the possibility of hot-switching and do not exceed a maximum peak current value per plate of 3amperes during the initial cycles of the hot-switching transient. If hot-switching is required in operation, the use of choke-input circuits is recommended for maximum reliability and for long life. Such circuits limit the hot-switching current to a value no higher than that of the peak plate current.

* May deviate ±10 per cent from rated value provided such deviation occurs for less than 2 per cent of operating time.

5690



5690

FULL-WAVE VACUUM RECTIFIER

PEAK HEATER-CATHODE VOLTAGE:*

Heater negative with respect to cathode . . . 400 max. volts

Heater positive with respect to cathode . . . 400 max. volts

BULB TEMPERATURE. 200 max. °C

Typical Operation as Full-Wave Rectifier

with Capacitor-Input Filter:

AC Plate-to-Plate Supply Voltage (RMS). 700 volts

Filter-Input Capacitor[▲]. 10 μ f

Effective Plate-Supply Resistance per Plate . 350 ohms

DC Output Voltage at Input to Filter (Approx.):

At half-load current of 55 ma 415 volts

At full-load current of 110 ma 355 volts

Voltage Regulation (Approx.):

Half-load to full-load current 60 volts

Typical Operation as Full-Wave Rectifier

with Choke-Input Filter:

AC Plate-to-Plate Supply Voltage (RMS). 700 volts

Filter Input Choke 10 henries

DC Output Voltage at Input to Filter (Approx.):

At half-load current of 67.5 ma 305 volts

At full-load current of 135 ma 300 volts

Voltage Regulation (Approx.):

Half-load to full-load current 5 volts

SPECIAL RATINGS & PERFORMANCE DATA

Shock Rating:

Impact Acceleration 500 max. g

Tubes are held rigid in three different positions in a Navy Type, High Impact (flyweight) Shock Machine and are subjected to 500 g impact acceleration.

Fatigue Rating:

Vibrational Acceleration 2.5 max. g

Tubes are rigidly mounted and subjected in each of three positions to 2.5 g vibrational acceleration at 25 cycles per second for 32 hours.

CHARACTERISTICS RANGE VALUES FOR EQUIPMENT DESIGN

	Note	Min.	Max.	
Heater Current	1	2.30	2.50	amp

* For maximum reliability, it is recommended that the cathode of each unit be connected directly to the mid-point or one side of the heater winding.

▲ Higher values of capacitance than indicated may be used but the effective plate-supply resistance should be increased to prevent exceeding the maximum rating for peak plate current. See Rating Chart II.



5690

5690

FULL-WAVE VACUUM RECTIFIER

	Note	Min.	Max.	
Heater-Cathode Current:				
Heater negative with respect to cathode . . .	1,2	-	30	μ amp
Heater positive with respect to cathode . . .	1,2	-	30	μ amp
Tube Voltage Drop	1,3	15	19	volts

Note 1: With 6.3 volts on heater of unit No.1 connected in parallel with heater of unit No.2.

Note 2: With 300 volts between heater and cathode.

Note 3: With dc voltage per plate adjusted to give dc plate current of 150 ma. per unit.

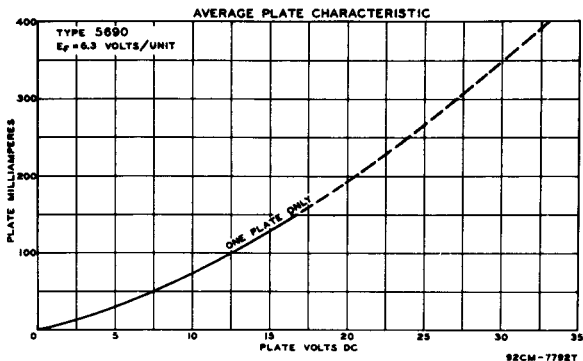

RATING CHARTS and OPERATION CHARACTERISTICS

Rating Chart I represents graphically the relationships between absolute maximum ac voltage input and absolute maximum dc output current derived from the fundamental ratings for conditions of capacitor-input and choke-input filters. This graphical presentation gives the equipment designer considerable latitude in choice of operating conditions.

Rating Chart II represents graphically the relationships between maximum rectification efficiency and absolute maximum dc output current per plate for conditions of capacitor input to filter.

Rating Chart III represents graphically the relationships between minimum plate-supply resistance per plate and absolute maximum ac plate-supply voltage per plate under no-load conditions for conditions of capacitor input to filter when occasional hot-switching is employed.

5690



5690

FULL-WAVE VACUUM RECTIFIER

The *Operation Characteristics for the 5690 in Full-Wave Circuit with 4 μ f, 10 μ f, and 20 μ f-Capacitor Input to Filter* show not only typical operating curves for different plate-supply voltages and different effective plate-supply resistances, but also by means of boundary line "AED" the limiting current and voltage relationships presented on *Rating Chart I*.

The *Operation Characteristics for the 5690 in Full-Wave Circuit with Choke Input to Filter* show not only typical operating curves for different plate-supply voltages but also by means of boundary line "ABC" the limiting current and voltage relationships presented on *Rating Chart I*. These curves also give information as to the effect of various sizes of chokes on regulation. The solid-line curves show the dc voltage outputs which would be obtained if the filter chokes had infinite inductance. The long-dash lines radiating from the zero position are boundary lines for various sizes of chokes as indicated. The intersection of one of these lines with a solid-line curve indicates the point on the curve at which the choke no longer behaves as though it had infinite inductance. To the left of the choke boundary line, the regulation curves depart from the solid-line curves as shown by the representative short-dash regulation curves.

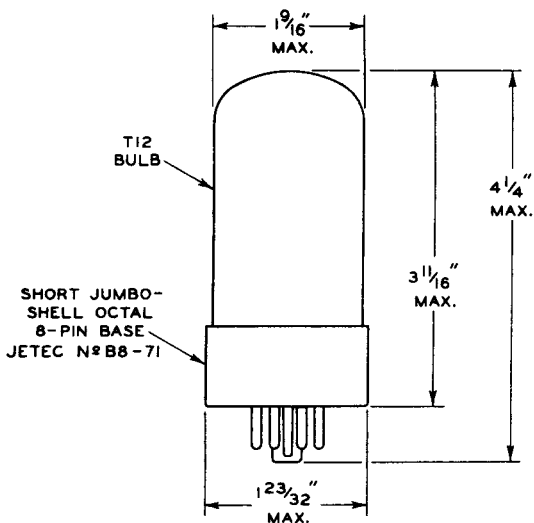

APRIL 1, 1953

TUBE DEPARTMENT

TENTATIVE DATA 2

RADIO CORPORATION OF AMERICA, HARRISON, NEW JERSEY



5690

5690

RATING CHART I

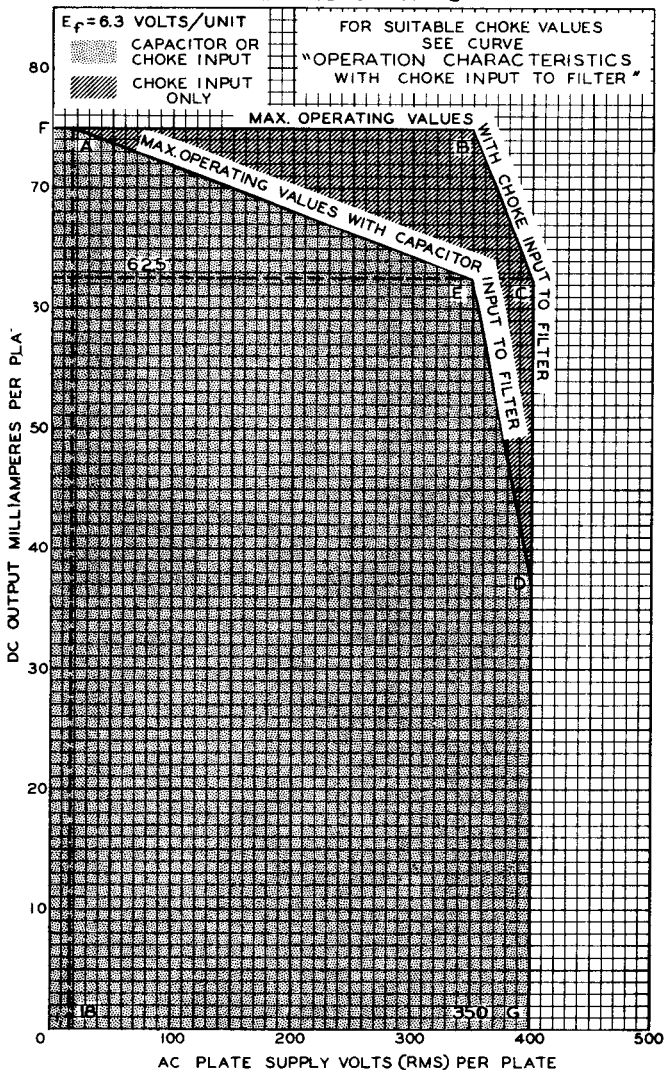

5690



5690

RATING CHART II CAPACITOR INPUT TO FILTER

 $E_f = 6.3 \text{ VOLTS/UNIT}$

MAX. PEAK PLATE CURRENT PER PLATE = 375 MA

$$\text{RECTIFICATION EFFICIENCY} = \frac{\bar{E}}{\sqrt{2} E_s}$$

 WHERE \bar{E} = DC OUTPUT VOLTS AT INPUT TO FILTER

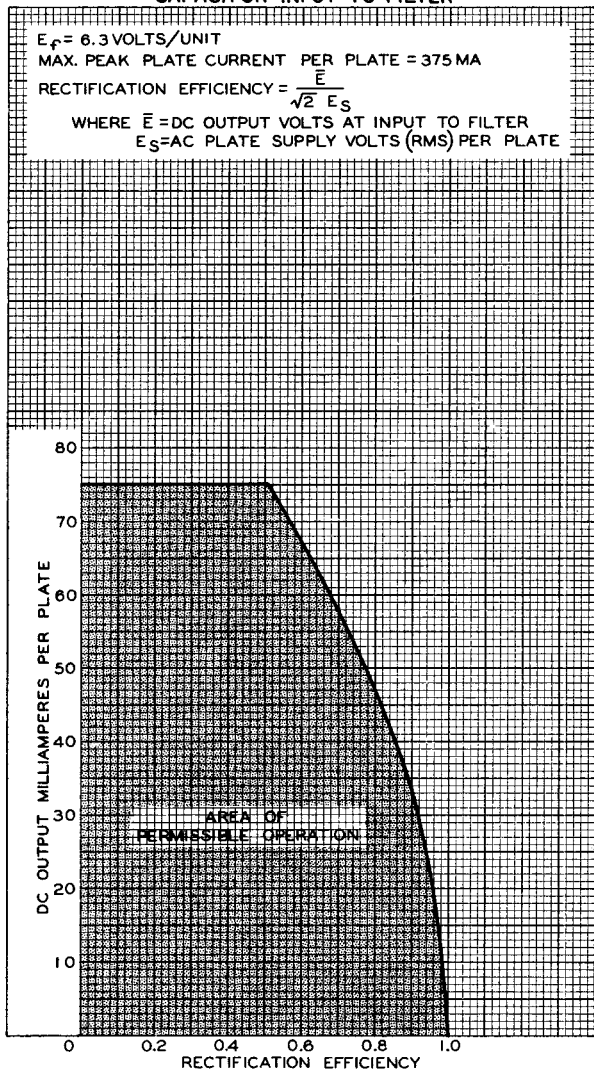
 E_s = AC PLATE SUPPLY VOLTS (RMS) PER PLATE

JAN. 9, 1953

TUBE DEPARTMENT

92CM-7894

RADIO CORPORATION OF AMERICA, HARRISON, NEW JERSEY



5690

5690

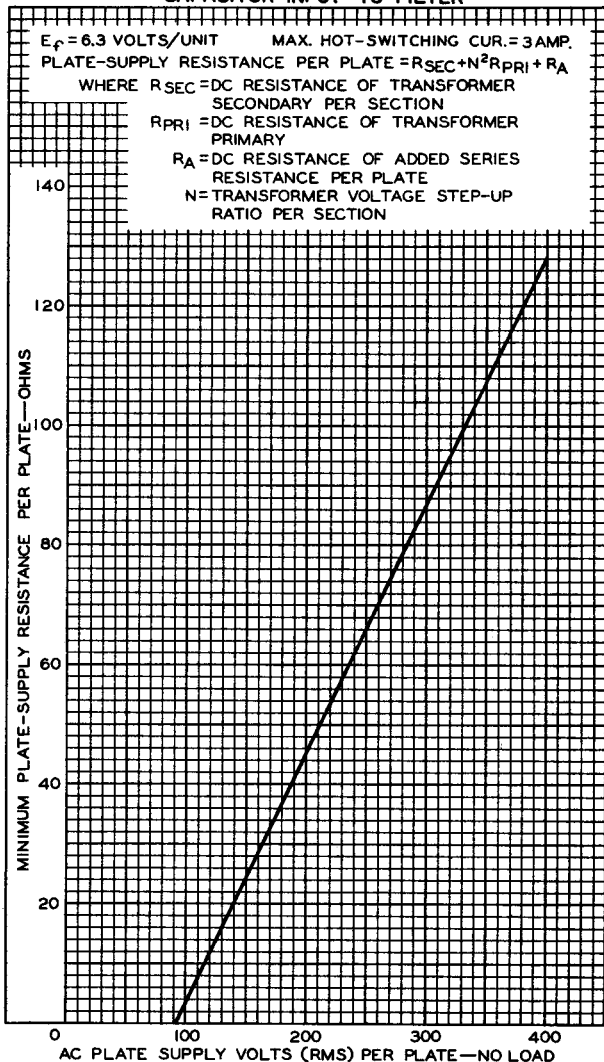
RATING CHART III
CAPACITOR INPUT TO FILTER

JAN. 9, 1953

TUBE DEPARTMENT
RADIO CORPORATION OF AMERICA, HARRISON, NEW JERSEY

92CM-7895

5690



5690

OPERATION CHARACTERISTICS

FULL-WAVE CIRCUIT, CAPACITOR INPUT TO FILTER

$E_f = 6.3$ VOLTS/UNIT
 CAPACITOR (C) INPUT TO FILTER: $C = 4\mu F$
 TOTAL EFFECTIVE PLATE-SUPPLY RESISTANCE (OHMS) = R_s
 SUPPLY FREQUENCY = 60 CPS

CURRENT-AND-VOLTAGE
 BOUNDARY LINE 'DEA' IS
 THE SAME AS SHOWN ON
 RATING CHART I

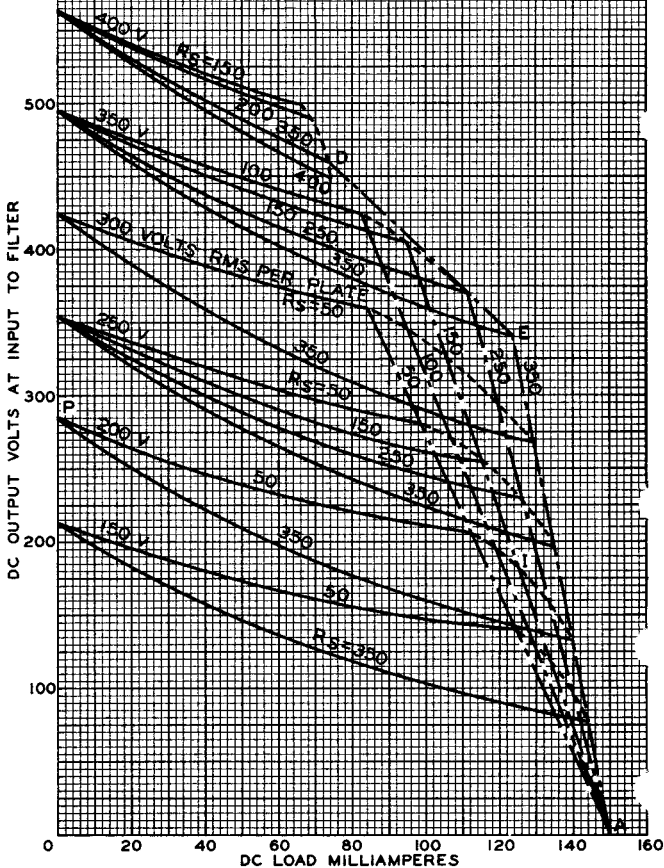

MAY 9, 1952

TUBE DEPARTMENT
 RADIO CORPORATION OF AMERICA, HARRISON, NEW JERSEY

92CM-7794



5690

5690

OPERATION CHARACTERISTICS FULL-WAVE CIRCUIT, CAPACITOR INPUT TO FILTER

$E_f = 6.3$ VOLTS/UNIT
 CAPACITOR (C) INPUT TO FILTER: $C = 10\mu F$
 TOTAL EFFECTIVE PLATE - SUPPLY RESISTANCE (OHMS) = R_s
 SUPPLY FREQUENCY = 60 CPS

CURRENT-AND-VOLTAGE
 BOUNDARY LINE 'DEA' IS
 THE SAME AS SHOWN ON
 RATING CHART I

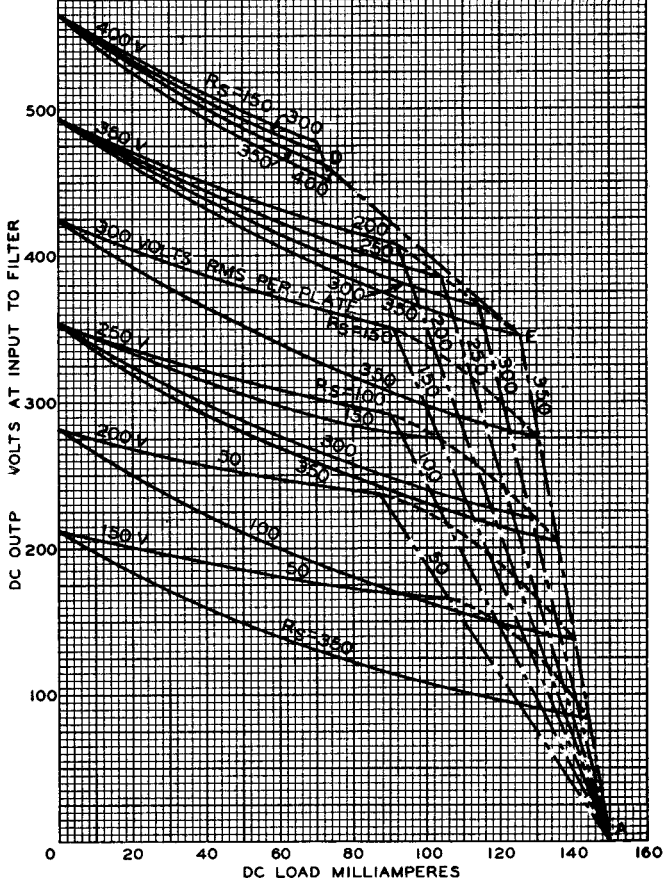

5690



5690

OPERATION CHARACTERISTICS FULL-WAVE CIRCUIT, CAPACITOR INPUT TO FILTER

$E_p = 6.3$ VOLTS/UNIT
CAPACITOR (C) INPUT TO FILTER: $C = 20\mu f$
TOTAL EFFECTIVE PLATE-SUPPLY RESISTANCE (OHMS) = R_s
SUPPLY FREQUENCY = 60 CPS

CURRENT-AND-VOLTAGE
BOUNDARY LINE 'DEA'
IS THE SAME AS SHOWN ON
RATING CHART I

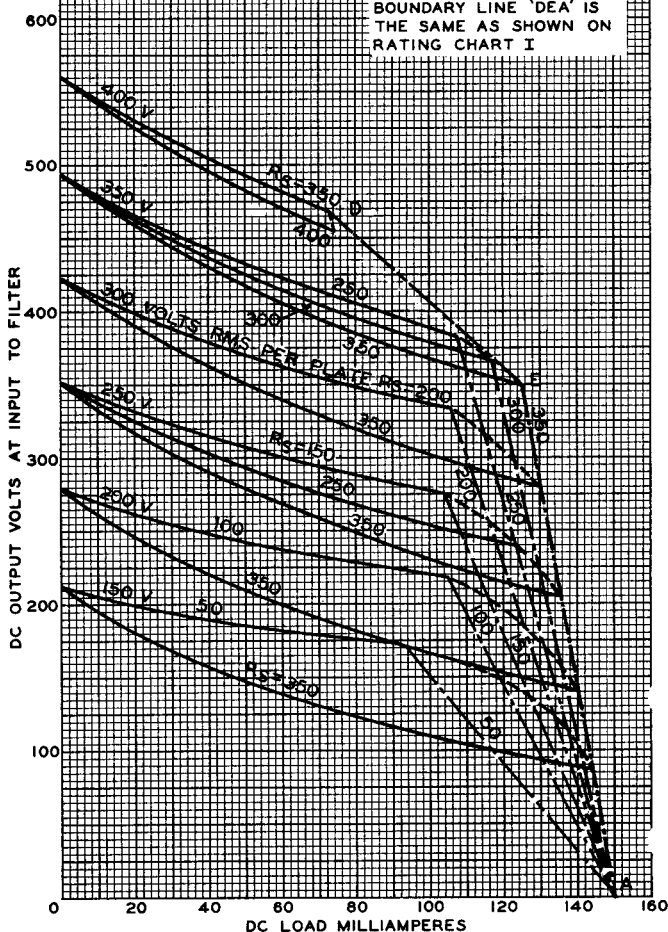

MAY 7, 1952

TUBE DEPARTMENT
RADIO CORPORATION OF AMERICA, HARRISON, NEW JERSEY

92CM-7793



5690

5690

OPERATION CHARACTERISTICS FULL-WAVE CIRCUIT, CHOKE INPUT TO FILTER

