

March 1978

**CRYSTALS: Specifications for
intel[®] Components**

Bruce McCormick
Microcomputer Applications

The material in this Application Note is for **Informational** purposes only and is subject to change without notice. Intel Corporation has made an effort to verify that the material in this document is correct. However, Intel Corporation does not assume any responsibility for errors that may appear in this document.

The following are trademarks of Intel Corporation and may be used **only** to describe Intel products:

ICE
INSITE
INTEL
INTELLEC
LIBRARY MANAGER

MCS
MEGACHASSIS
MICROAMP
PROMPT
UPI

CRYSTALS: Specifications for Intel Components

Contents

INTRODUCTION	1
CRYSTAL OPERATION — BRIEF THEORETICAL EXPLANATION	1
CIRCUIT CONFIGURATIONS FROM VARIOUS MANUALS/EXPLANATION	2
Series 10 pf Capacitor	2
Parallel 20 pf Capacitor to Ground	2
8224 Overtone Application (Tank Circuit)	2
Precise Timing Applications	3
WHAT IF I USE A CRYSTAL OTHER THAN SPEC'D	3
SPECIFICATIONS	3
Intel Component Crystal Requirements	3
Suggested Suppliers. Part Numbers	4

INTRODUCTION

The following brief note is intended to answer the simpler questions on crystal specifications and their operation with the various Intel components. First, a theoretical explanation of the crystal is given to aid the user in understanding crystal operation. This includes a discussion of the parameters necessary for proper specification to the vendor. Following this section are explanations of the various crystal-capacitor configurations seen in the Intel User's Manuals and data sheets; why they are suggested for proper crystal operation and what might happen if they weren't there.

The final section of this note provides a list of suggested crystal specifications, suppliers, and part numbers for the highest frequency crystals possible for the various Intel components that require them. In no way does this list represent the only crystals or suppliers available. This section is conveniently preceded by a discussion of problem areas that may result if a user is using the wrong crystal required for the component.

CRYSTAL OPERATION — BRIEF THEORETICAL EXPLANATION

Understanding Crystal Operation

Crystals are piezoelectric devices which transform voltage energy to mechanical vibrations and voltage oscillations. The frequency of the crystal is largely dependent on its thickness, with thinner crystals producing a higher frequency.

Crystals are generally specified as being series or parallel resonant, but all crystals are in actuality both. Vendors supply crystals as series or parallel resonant based on the desired frequency and the crystal's **relative ability** to generate the frequency in that mode. On a conceptual basis, when using a crystal as series resonant, its output is in phase with its input, whereas using the crystal as parallel resonant will result in a phase shift from its input to output.

Different LSI components prefer different crystals due to the nature of their internal oscillator design. In general, Intel **bipolar** components have a non-inverting, **bidirectional drive oscillator**, whereas NMOS components use an inverting oscillator. Non-inverting oscillators prefer series resonant crystals (as the series resonant crystal has 0 degree net phase **shift**), while inverting oscillators prefer crystals which are parallel resonant. Since a crystal has both a series and parallel **operating** frequency, many times any crystal will seem to work when connected to a component.

When giving the specifications to a crystal vendor for a crystal, it is helpful to understand its equivalent circuit as shown in Figure 1. The impedance of this circuit (neglecting **R** to simplify matters for conceptual purposes) can be calculated and plotted against frequency (Figure 2). This frequency-impedance plot illustrates the two different operating modes of crystal. ω_s (series resonance) occurs when the impedance (reactance) is zero and ω_p (parallel resonance) occurs when the impedance goes to infinity and appears inductive.

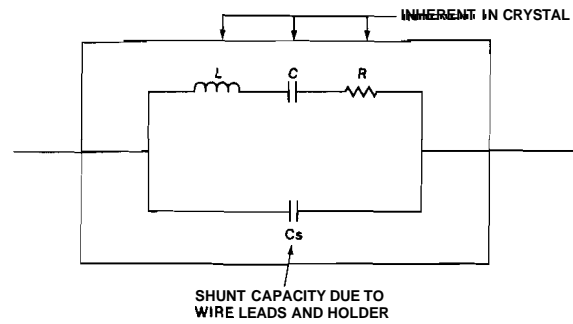

Figure 1

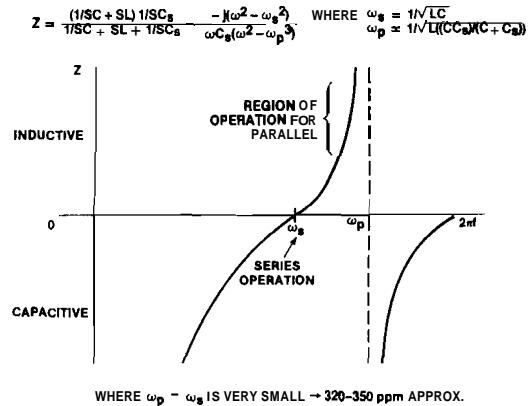

Figure 2

When operating at series resonance (ω_s) the equivalent circuit of the crystal becomes a simple resistor R_s (Figure 3; remember, **R** was neglected in the impedance calculation). This R_s value must be specified to the crystal vendor when buying a crystal.

This parameter becomes a problem with lower frequency or overtone crystals (thicker, more resistance) and a buffer that doesn't have sufficient gain to drive those crystals (*i.e.*, loop **gain** becomes less than 1). Overtone crystals also have R_s problems as their R_s is associated with the fundamental frequency of the crystal, not the 3rd harmonic or overtone. The 8224 is particularly sensitive to R_s with 27 MHz overtone applications.

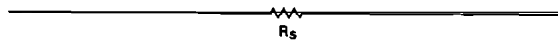

Figure 3

Conversely, if operating at ω_p (parallel resonance), the crystal appears inductive in the circuit (Figure 4). Since the crystal appears inductive, any changes in reactance that the crystal sees will have the effect of pulling the frequency of the crystal. As a result of this, the amount of load capacitance seen by the crystal in the circuit configuration becomes important. This load capacitance, CL, is the dynamic capacity of the total circuit measured across the terminals of the crystal. The amount of this capacitance should always be specified to the crystal vendor if the crystal will be operating at parallel resonance.

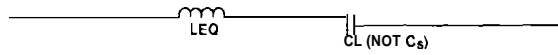

Figure 4

CIRCUIT CONFIGURATIONS FROM VARIOUS MANUALS/EXPLANATIONS

Series 10 pF Capacitor Included (Figure 5)

This additional capacitor is recommended at times to debias the crystal. Due to the component's internal circuit, a small DC bias may exist across the crystal which would strain the crystalline structure. It is also provided for trimming the frequency of the crystal to compensate for the loading effects of the component.

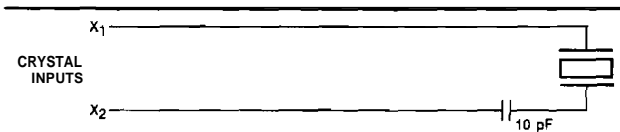

Figure 5

Parallel 20 pF Capacitors to Ground (Figure 6)

Crystals can oscillate at several different frequencies, each emanating from a different direction of vibration in the crystal. For a crystal to oscillate during startup in its fundamental frequency, it is best for the crystal to see the slew rate (Figure 7) of the pulse provided from the oscillator to be as close to the operating frequency as possible.

These 20 pF capacitors act as a high frequency filter to create a slew rate closer to the fundamental frequency of the crystal. As can be guessed, lower frequency crystals are more susceptible to the problem of not starting up in the fundamental frequency.

Capacitors are placed on both sides of the crystal as some components have bidirectional drive buffers (i.e., 1/2 of cycle drive from one side, other half from opposite side). A crystal that needs these extra 20 pFs to ground will be characterized by starting up at a 3rd or 5th harmonic instead of the fundamental frequency. The CL specifications in the specification section takes into consideration these extra 20 pF capacitors required for some Intel components for proper operation.

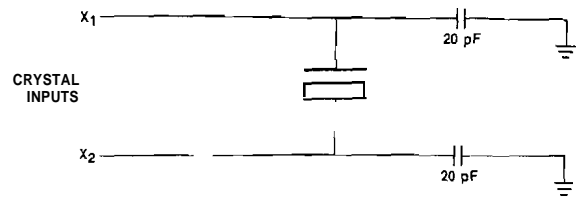

Figure 6

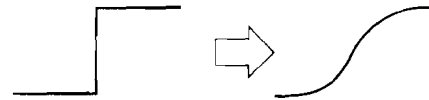

Figure 7

Tank Circuit

On some Intel components, provision is made for a tank circuit. This is for the use of an overtone crystal; i.e., one that is working at a harmonic (generally its 3rd). The tank circuitry is a filter to bypass the lower and higher, unwanted frequencies to ground while appearing "open" to the desired frequency. It is necessary to use tank circuits and overtone crystals when in the 25 + MHz range and above. Fundamental crystals are difficult to make in this frequency range as the crystal must be thinner for higher frequencies.

A circuit that has been used for the 8224 in 27 MHz overtone crystal applications is shown in Figure 8.

This filter can be approximated through formulas where afterwards it will be necessary to tweak the component values for optimization. The formula used to get the original component values is:

$$f = \frac{1}{2\pi\sqrt{L_1 C_1}} \text{ where } f = \text{overtone frequency}$$

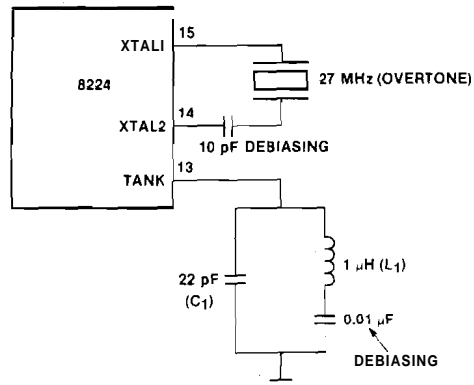

Figure 8

Precise Timing Applications

For applications where precise timing is required, using an external drive could produce better results. The accuracy of the component clock over temperature will be as accurate as the external drive. It is difficult to guarantee the temperature stability of the output frequency of the Intel component as fabrication process parameters vary, causing large ranges of input impedance and hence a large range of loading for the crystal.

WHAT IF I USE A CRYSTAL OTHER THAN SPECIFIED?

Series vs. Parallel

As discussed in the theoretical section, all crystals have a series and parallel operating mode. Placing a series crystal on a device **requiring** a parallel (i.e., there is an inverting oscillator between the two inputs) will force the crystal to oscillate in its parallel mode (and vice versa). A system with the wrong crystal will exhibit its clock frequency shifted a small percentage (about 320 to 350 parts per million) from the specified crystal frequency. When using the wrong crystal, any attempts to trim the frequency to its specified value by **using** small parallel (series if series crystal) variable capacitors will cause the crystal to stop oscillating, as predicted by theory. If the correct crystal is being used, trimming can be done.

In applications where accuracy is not important, series crystals are sometimes substituted for parallel in the circuit. For instance, the 8048 has been characterized to be compatible with the series color burst TV crystal

(3.579545 MHz). If this crystal is used, a small frequency shift will occur, as noted above.

Insufficient Drive Level

The drive level specified is the maximum amount of power that is expected for the crystal to dissipate. If the crystal can't handle this level, frequency drift may occur or possible fracture of the crystal. In other words, if the crystal used cannot handle the oscillator drive level, long term reliability problems may occur.

Rs Too High

The higher Rs is, the higher the drive capability of the oscillator has to be to get the crystal to oscillate. Too much Rs may result in the oscillator not being able to drive the crystal; i.e., the loop gain is less than one. Overtone applications are particularly sensitive to this as thicker crystals are used (lower fundamental frequency, more resistance).

SPECIFICATIONS

Intel Component Crystal Requirements

The following is a list of suggested specifications for crystals to be used with Intel components. In most instances the upper frequency limit is given, with exceptions being footnoted.

Component (Function)	Process	Component Divide By	Crystal Type	Fundamental Overtone	Upper Limit Frequency
1. 4201A (Clock Generator)	CMOS	—	Series	f	5.185 MHz
2. 8035148149, 8748 (8-Bit CPU)	NMOS	15	Parallel	f	6.0 MHz
3. 8748/8035-8 (8-Bit CPU)	NMOS	15	Parallel	f	3.6 MHz
4. 804118741 (Universal Peripheral Interface)	NMOS	15	Parallel	f	6.0 MHz
5. 8085A (8-Bit CPU)	NMOS	2	Parallel	f	6.25 MHz/6.144 MHz ⁽¹⁾
6. 8085A-2 (8-Bit CPU)	NMOS	2	Parallel	f	10.0 MHz
7. 8202 (Dynamic RAM Controller)	Bipolar	—	Series	f	25 MHz
8. 8224 (8080A Clock Generator)	Bipolar	—	Series	f10	27 MHz/18.432 MHz ⁽²⁾
9. 8284 (8086 Clock Generator)	Bipolar	3	Series	f	24 MHz/15 MHz ⁽³⁾

Additional suggested specifications:

Frequency Tolerance:	± 0.005% (up to the user)
CL (Load Capacitance):	= 20-35 pF (not necessary when specifying series)
Rs (Equivalent Series Resistance):	<75 ohms
Cs (Shunt Capacitance):	<7 pF
Drive Level:	<10 MHz crystal 10 milliwatts >10 MHz crystal 5 milliwatts

- Notes:**
- 6.144 MHz is commonly used as convenient baud rates can be generated from this frequency.
 - 27 MHz is max. 18.432 is common crystal used which gives maximum clock rate for 8080A. Fundamental crystal should be used for the 18.432 MHz application.
 - Used for either a 8 or 5 MHz output clock, respectively.

Holder specifications are up to the user. A standard popular one that provides ample lead length is HC-331U (0.750"W x 0.765"H, 1.5" lead length with spacing of 0.486") and can be used for frequencies up to 4 MHz. After 4 MHz a smaller holder can be used such as HC-18/U (0.435"W x 0.530"H, 1.5" lead length with spacing of 0.192"). All crystals listed in the following table will fit in the HC-331U holder. Other standard holders are available.

Suggested Suppliers, Part Numbers

The following are two vendors (which are among many) that supply crystals to the specifications given earlier and their part numbers (given in order of frequency). The user should make sure that the holder type associated with these part numbers is acceptable in their application.

f	Parallell Series	Crystek ⁽¹⁾ Corp.	CTS Knight, ⁽²⁾ Inc.
3.6 MHz	P	**	**
5.185 MHz	S	CY8A	**
6.0 MHz	P	**	MP060
6.144 MHz	P	**	MP061
6.25 MHz	P	**	MP062
10.0 MHz	P	**	MP10A
15.0 MHz	S	CY15A	MP150
18.432	S	CY19B*	MP184*
24.0 MHz	S	**	MP240
25.0 MHz	S	**	MP250
27.0 MHz	S (overtone)	CY27A	MP270

¹Intel also supplies a crystal numbered 8801 for this application.

²Contact vendor with the appropriate specifications.

- Notes: 1. Address: 1000 Crystal Drive, Fort Meyers, Florida 33901
 2. Address: 400 Reimann Ave., Sandwich, Illinois

The user is not limited to these vendors or frequencies. The frequency chosen by the user should take into consideration convertibility to desired baud rates and the system timings that must be met.

In summary, to obtain a crystal for the user's application, it is necessary to give the crystal vendor the following information:

- Series or parallel
- Fundamental or overtone
- Rs (series), Cs (shunt)
- CL if parallel
- Drive Level
- Frequency tolerance
- Holder type

For a select few crystals, vendor numbers were given for two different vendors. With the above information, most vendors can make the desired crystal whether or not they have it as a standard part.